

SEGA

V I R T U A
Fighter

SERVICE MANUAL

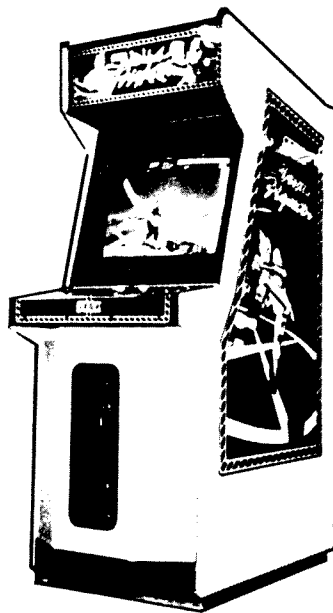

SEGA ENTERPRISES, LTD.

Manual No. 999-0222



V I R T U A *Fighter*

Table Of Contents

| | Page |
|---|-------|
| 1. Introduction | 1 |
| 2. Game Handling Precautions | 2 |
| 3. Prevention of Counterfeiting..... | 3 |
| 4. Installation Precautions | 4-5 |
| 5. Part Name, Locations..... | 6 |
| 6. Switch Unit | 7 |
| 7. Fluorescent Lamp Replacement | 8 |
| 8. Monitor Adjustment | 9-10 |
| 9. Printed Circuit Board Handling Precautions | 11 |
| 10. Test Mode..... | 12-33 |
| 11. Game Board Assembly | 34 |
| 12. Shift Case Assembly (Card Cage) | 35 |
| 13. Fluorescent Lamp Assembly | 36 |
| 14. Control Panel Assembly..... | 37 |
| 15. Switch Bracket | 38 |
| 16. Sound Board Assembly..... | 39 |
| 17. Power Unit Assembly | 40 |
| 18. Wire Color Code..... | 41 |
| 19. Wiring Diagram | 42 |

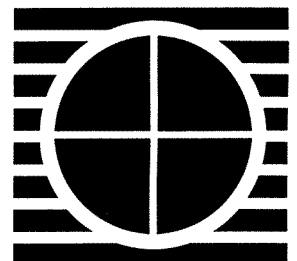
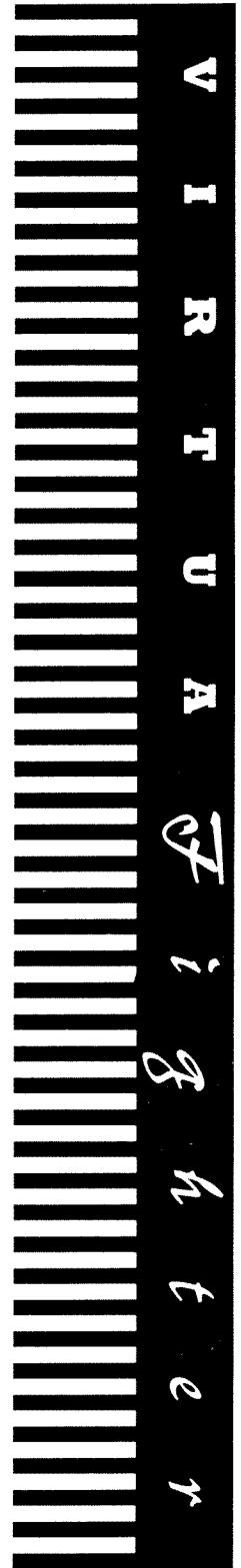

NOTE: Descriptions in this manual are subject to change without prior notice.

Introduction

SEGA ENTERPRISES, LTD., supported by its high electronic technology of LSIs, microprocessors, etc. and a wealth of experience, has for more than 30 years been supplying various innovative and popular game machines to the world market. This Owner's Manual is intended to provide detailed descriptions together with all the necessary information covering the general operation of electronic assemblies, electromechanicals, servicing control, spare parts, etc., as regards VIRTUA FIGHTER, a new SEGA product.

This manual is intended for those who have knowledge of electricity and technical expertise especially in ICs, CRTs, microprocessors, etc. Carefully read this manual to acquire sufficient knowledge before working on the machine. Should there be a malfunction, non-technical personnel should under no circumstances touch the interior system. Should such a case arise, contact our Main Office or the closest branch office listed as follows:

SEGA ENTERPRISES, INC. (U.S.A.)
CUSTOMER SERVICE
45133 Industrial Drive
Fremont, California 94538, U.S.A.

Phone: 415-802-1750
Fax: 415-802-1754

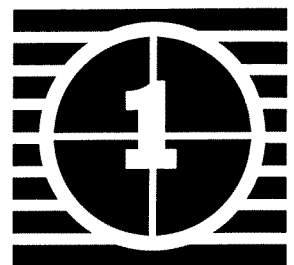
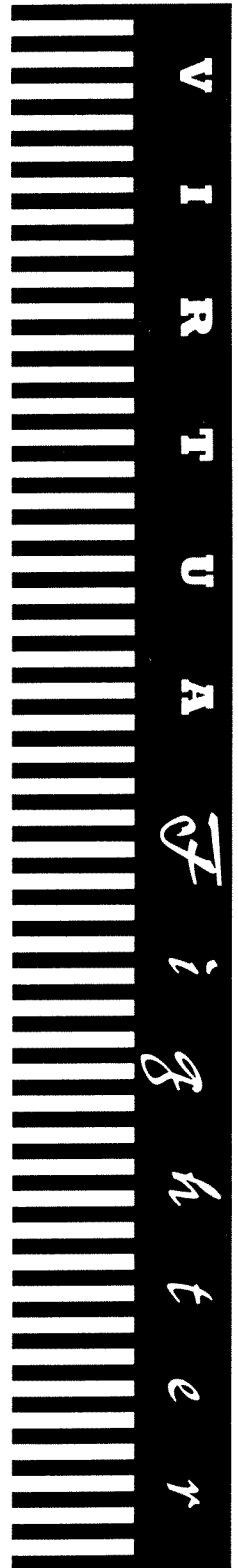

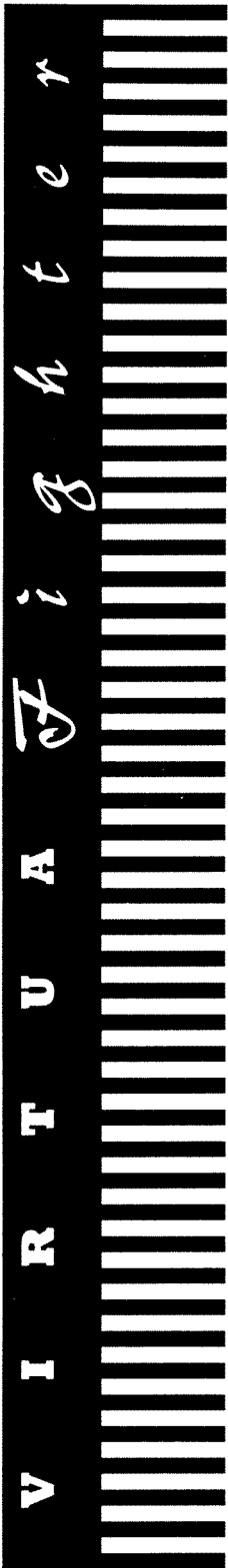

GAME HANDLING PRECAUTIONS

When installing or inspecting the machine, be very careful of the following points and pay attention to ensure that the player can enjoy the game safely.

- ✦ Be sure to turn the power OFF before working on the machine.
- ✦ To insert or pull out the plug quickly is dangerous.
- ✦ It is necessary to make sure that the power cord or the grounding wire is not exposed on the road, etc. in a manner so as to be dangerous. Make sure that grounding connections are made safely at the position where so specified.
- ✦ Do not use any fuse that does not meet specified rating.
- ✦ Make complete connections for the IC board and other connectors. Insufficient insertion is very dangerous.
- ✦ The operating (ambient) temperature range is from 5°C to 40°C.
- ✦ When cleaning the CRT surfaces, use a soft, dry cloth. Do not apply chemicals such as thinner, benzine, etc.

Also, for the IC board circuit inspections, only the logic tester is allowed.

After confirming that there are no irregularities, turn the power ON.



PREVENTION OF COUNTERFEITING AND CONVERSION

★ LABELING

To prevent counterfeits and conversions, the following labels are put on all the SEGA products. When handling such goods, be sure to confirm the labels. They are used to prevent illegal acts such as the unauthorized copying of the products and the printed circuit boards thereof or carrying on business by manufacturing similar merchandise or by converting, selling or using such products or printed circuit boards.

★ Original Seal

The following seal is put on the machines manufactured by SEGA.

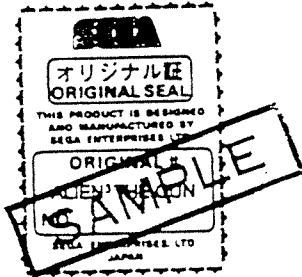

★ License Seal

The following seal is put on all SEGA kits, such as the printed circuit boards.

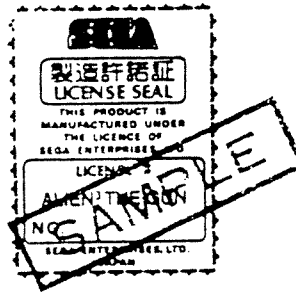

★ COPYRIGHT NOTICE

This SEGA product has the copyright notice as follows:

© SEGA 1993

This signifies that this work was disclosed in 1993 and is the property of SEGA ENTERPRISES, LTD.

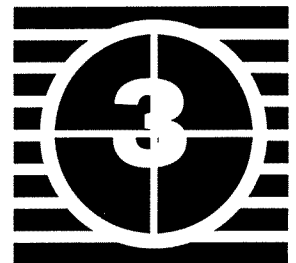



PRECAUTIONS CONCERNING INSTALLATION LOCATION

The VIRTUA FIGHTER is an indoor game machine. DO NOT INSTALL IT OUTSIDE UNDER ANY CIRCUMSTANCES. Even indoors, avoid installing in places mentioned below so as to ensure proper usage:

- ✦ Places subject to rain or water leakage, or condensation due to humidity.
- ✦ In the proximity of an indoor swimming pool and/or shower.
- ✦ Places subject to direct sunlight.
- ✦ Places subject to heat sources from heating units, etc., or hot air.
- ✦ Vicinity of anti-disaster facilities such as fire exits and fire extinguishers.
- ✦ Places subject to any type of violent impact.
- ✦ Dusty places.

INSTALLATION PRECAUTIONS

- ✦ Do not insert more than one electrical plug into the power plug socket.
- ✦ The per unit standard voltage/ampereage is 100—120V/5A.
- ✦ If an extension cord is to be used, use a cord of 5A or higher rating.

ELECTRIC CURRENT CONSUMPTION

- ✦ 2.1A, 250 Watts, 120VAC, 60 Hz



INSTALLATION PRECAUTIONS AND TRANSPORTATION OF MACHINE

ADJUSTING LEG ADJUSTERS

The VIRTUA FIGHTER has 2 Casters and 4 Leg Adjusters. Cause the Leg Adjusters to come into contact with the floor, and secure the machine in place. Make adjustments in the height of the Leg Adjusters in a manner so that the Casters will be raised approximately 5mm from the floor level, and secure the Adjusters' height by fastening the Nuts. (If the gap is less than 5mm, the machine may move while the game is being played and become dangerous.)

Side View

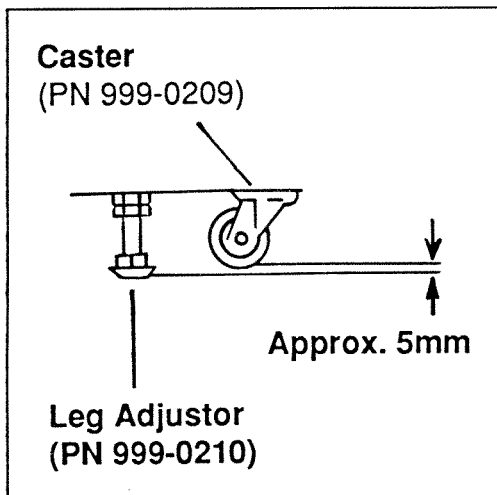

Bottom View

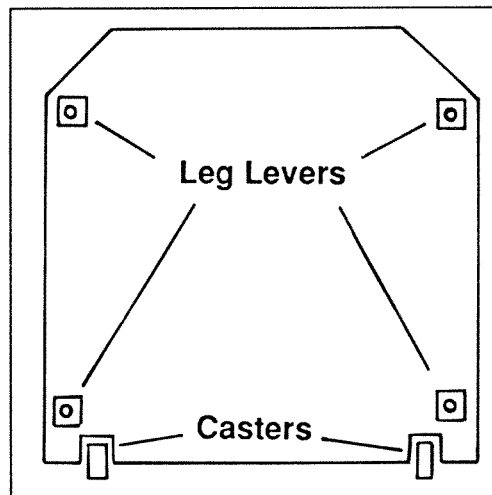

WHEN TRANSPORTING THE MACHINE

When moving the Cabinet, retract the Leg Adjusters to cause the Casters to make contact with the floor. Also, in the case where there are differences in floor levels, transport the Cabinet by holding the catches on both sides of the Cabinet and lifting it up.

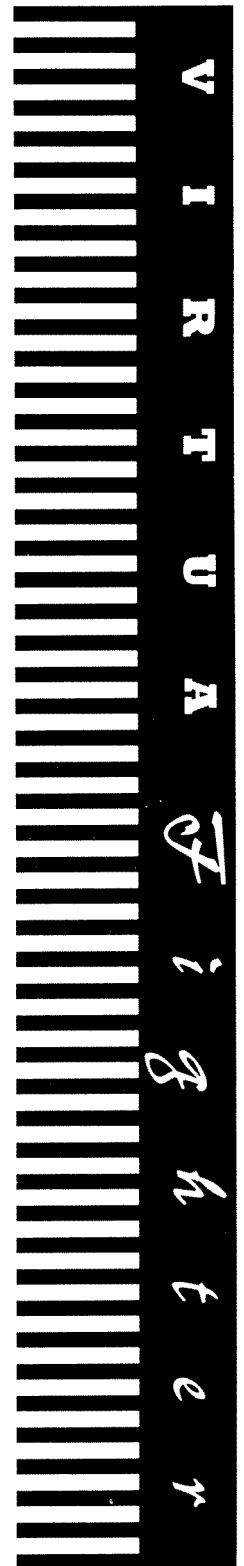

V
I
R
T
U
A
L
F
I
G
H
T
E
R

M MODEL SUR-007-01

| DEPTH | WIDTH | HEIGHT | WEIGHT |
|-------|-------|--------|-----------------|
| 41" | 30" | 75" | Approx 404 lbs. |

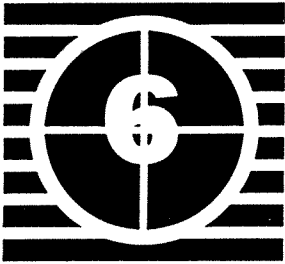
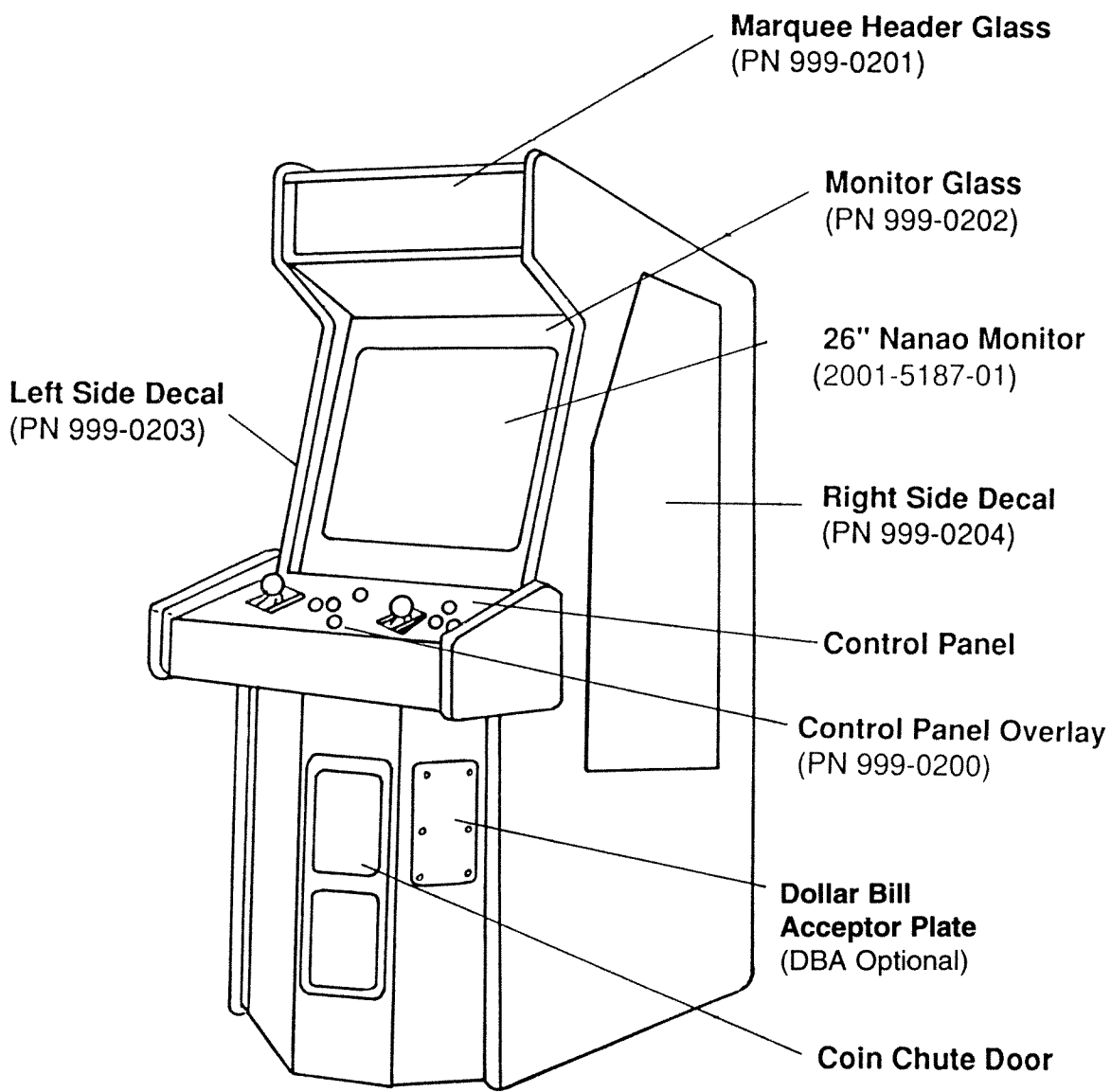

S WITCH UNIT

Open the coin chute door and the switch unit shown will appear. The functioning of each SW is as follows:

- ① SERVICE SWITCH (Service Button) gives credit without registering on the coin meter.
- ② TEST SWITCH for the handling of the test button, refer to the following pages.
- ③ SOUND VOLUME adjusts the sound volume of the Speaker.
- ④ COIN METER registers coins accepted for play.
- ⑤ DEGAUSS SWITCH corrects color impurity.

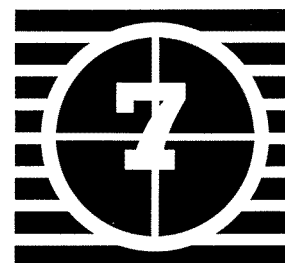
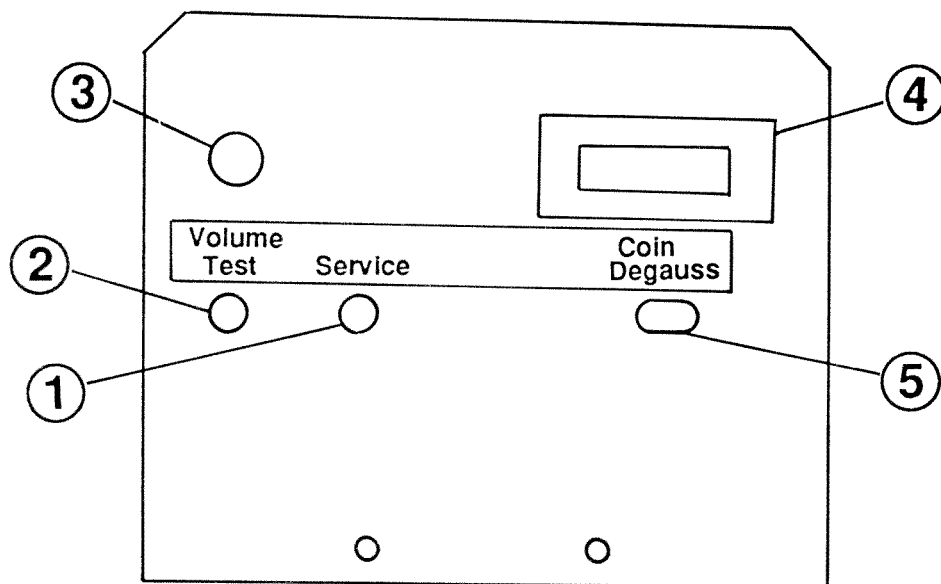

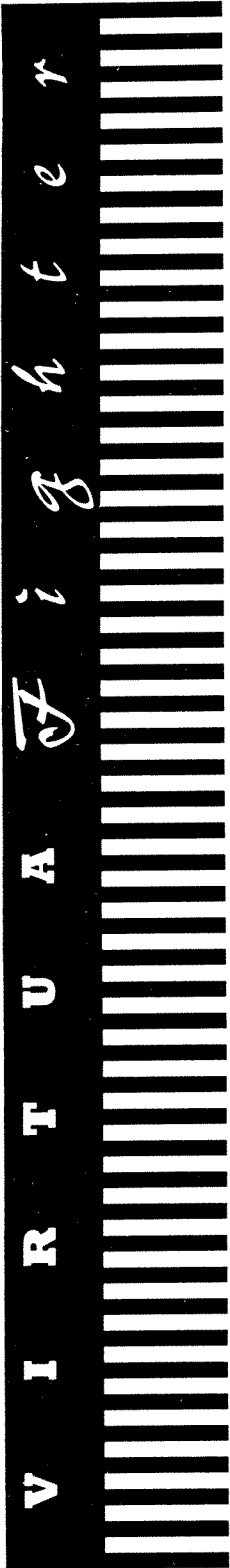

*F*LUORESCENT LAMP REPLACEMENT

- ① Remove (4) 8 x 1/2" Panhead Screws holding Top Header Retainer Bracket. Remove Retainer Bracket.
- ② Remove (4) 8 x 1/2" Panhead Screws holding Bottom Header Retainer Bracket. Remove Retainer Bracket.
- ③ Carefully remove Header Marquee Glass.
- ④ Replace 24" Lamp or Starter as needed.
- ⑤ Replace Glass, Top & Bottom Retainer Bracket with the 8 Screws that were previously removed.

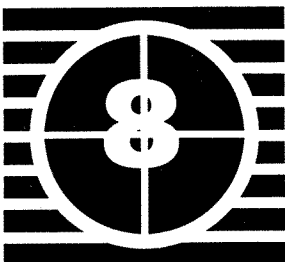
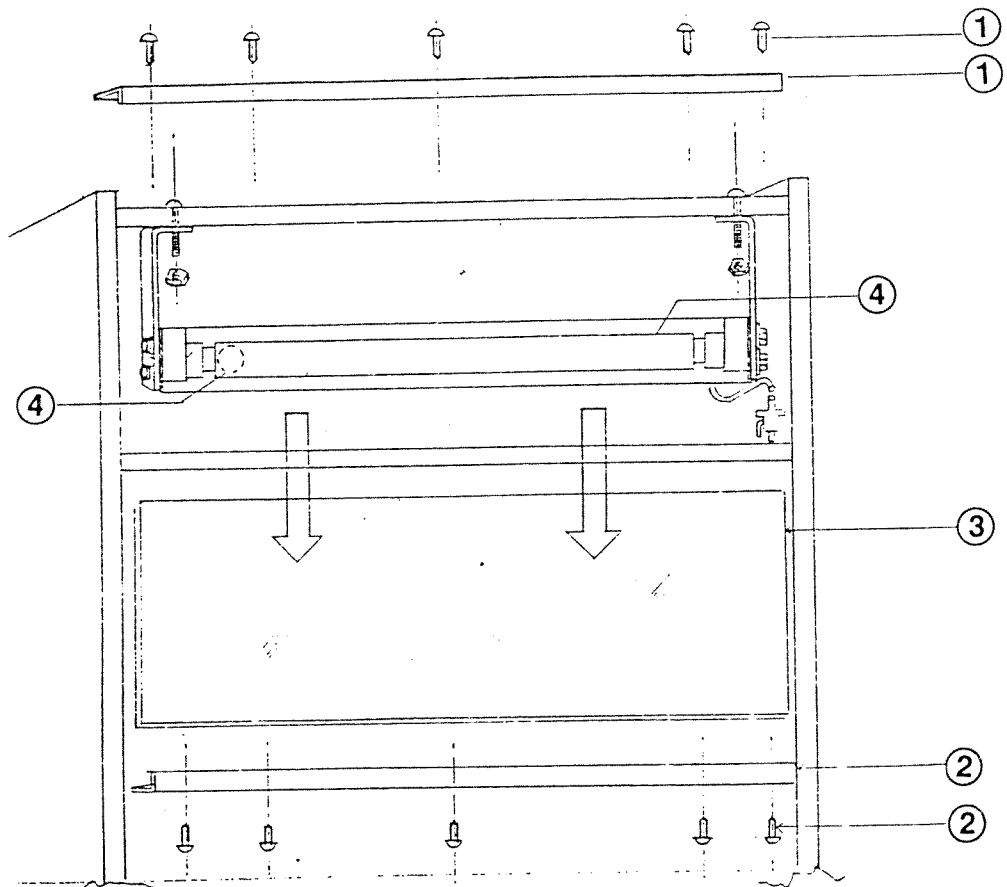

CONTROL PANEL/ MONITOR ADJUSTMENT

To unlatch Control Panel, open Coin Door, reach through Coin Door and lift Clamp Tab up. The Latches are located at the upper left and right corners of the Control Shelf. Once the Latches are opened, the Control Panel can be tilted down and the Monitor Glass removed. Remove the Monitor Bezel to gain access to the Monitor Controls.

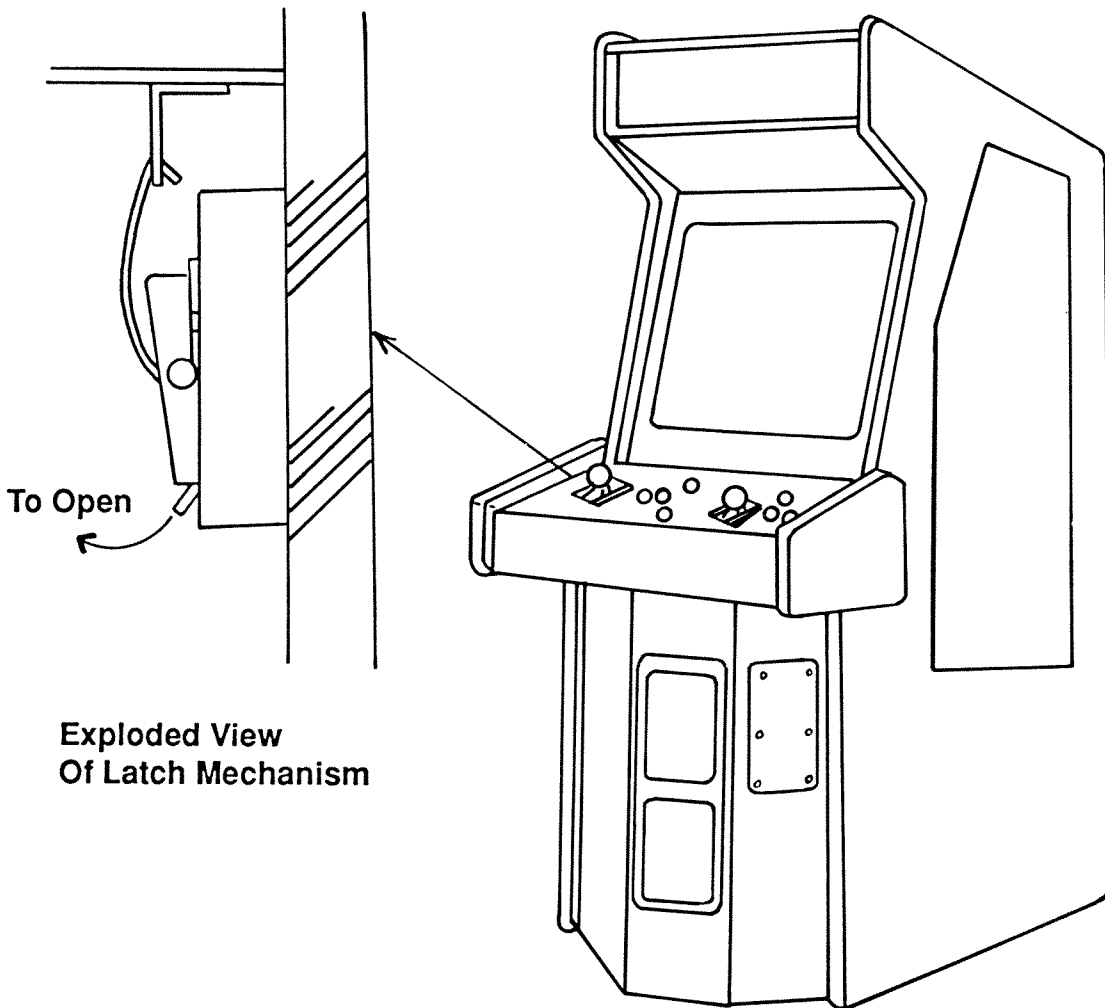

**Exploded View
Of Latch Mechanism**

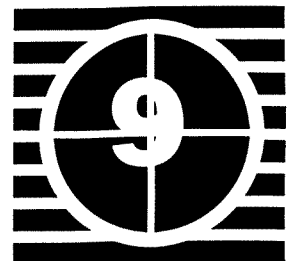



26" MONITOR

Remove the Control Panel, Monitor Glass and Bezel to make the monitor adjustments.

- ✦ V. POSI (Vertical Position Control) adjusts the vertical display position of the image.
- ✦ V. HOLD (Vertical Synchronization Control) adjusts the image running from left to right.
- ✦ V. SIZE (Vertical Size Control) adjusts the length of the screen.
- ✦ H. PHASE (Horizontal Position Control) adjusts the horizontal display position of the image.
- ✦ H. HOLD (Horizontal Synchronization Control) adjusts the image running from left to right.
- ✦ H. SIZE (Horizontal Size Control) adjusts the width of the screen. For adjustments, utilize the Alignment Screwdriver.
- ✦ BRIGHT (Brightness Control)
- ✦ B. GAIN ✦ G. GAIN ✦ R. GAIN
Adjusts colors (Ordinarily, B.C.R. BIAS should not be touched).
- ✦ FOCUS (Focus Control)
- ✦ SCREEN (Focus Control)
(Ordinarily, SCREEN should not be touched).

MAIN BOARD

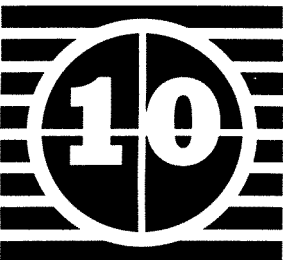
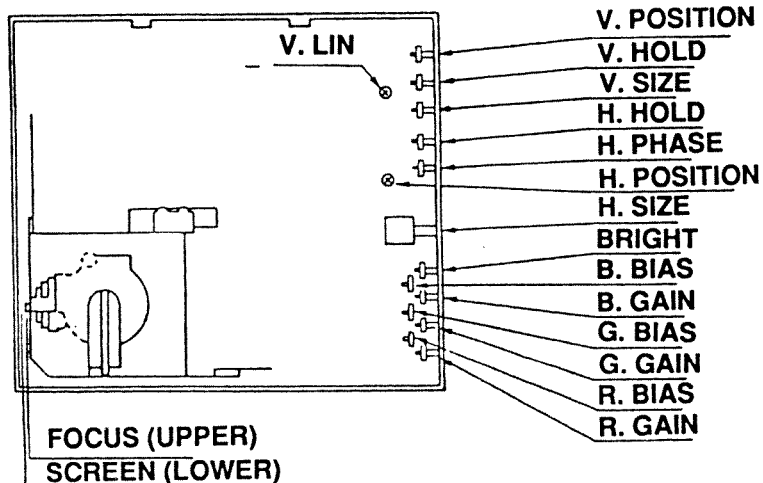

P R I N T E D C I R C U I T B O A R D H A N D L I N G P R E C A U T I O N S

- ✦ When installing and removing the IC Board, make sure that the cabinet's Main Power is OFF.
- ✦ Foreign matter, including dust on the IC Board, may cause malfunctioning (short circuit, combustion, etc., due to the Board's generation of heat) to occur. Therefore, keep the IC Board surfaces always clean.
- ✦ Completely perform the connections of the IC Board's and other item's Connectors. Insufficient connector insertion may cause the IC Board to be damaged. Therefore, pay careful attention to this point. Also, for the IC Board circuit inspection, only the usage of logic testers is permitted.
- ✦ The Model-1, when used without the Shield Case, may have a radio wave fault. Therefore, be sure to utilize the Ancillary Shield Case. Should any problem arise when the above-mentioned Shield Case is not utilized, SEGA will not be held responsible whatsoever.
- ✦ The contents of the product herein described are subject to change without notice.
- ✦ The DIP Switches on the I/O Board and Sound Board are all set to OFF at the time of shipment. Do not change the setting without good reason.





T **EST MODE**

This mainly checks if the operation of the Game Board is accurate, makes monitor color adjustments, and allows for Coin Assignments/Game Assignments setting adjustments.

SELECTION OF TEST ITEMS

- 1) Push the Test Switch to cause the following Test Item Menu to appear:

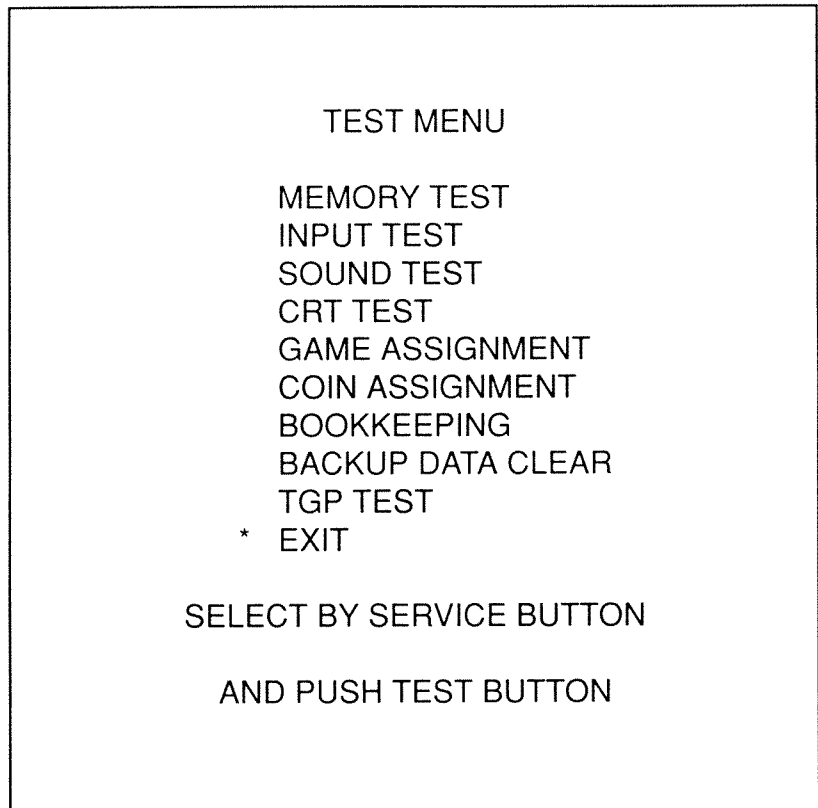

- 2) By pushing the Service Switch, bring the arrow mark "*" to the desired item and press the Test Button...
- 3) When the test has been completed, bring "*" to Exit and push the Test Button.



MEMORY TEST

Check the PCB's Memory ICs. When the IC is in good operating condition, GOOD will be indicated. If there exists any malfunctioning of the ICs, BAD will be indicated.

MEMORY TEST

* * * 837-7893 * * *

| | | | | | |
|-------|------|-------|------|-------|------|
| IC 4 | GOOD | IC 5 | GOOD | IC 6 | GOOD |
| IC 7 | GOOD | IC 8 | GOOD | IC 9 | GOOD |
| IC 10 | GOOD | IC 11 | GOOD | IC 12 | GOOD |
| IC 13 | GOOD | IC 14 | GOOD | IC 15 | GOOD |

* * * 837-8886 * * *

| | | | | | |
|-------|------|-------|------|-------|------|
| IC 19 | GOOD | IC 20 | GOOD | IC 21 | GOOD |
| IC 22 | GOOD | IC 23 | GOOD | IC 24 | GOOD |
| IC 67 | GOOD | IC 68 | GOOD | IC 69 | GOOD |
| IC 70 | GOOD | IC 71 | GOOD | IC 72 | GOOD |

PLEASE WAIT FOR A WHILE

Push the Test Button to have the Menu return on screen.

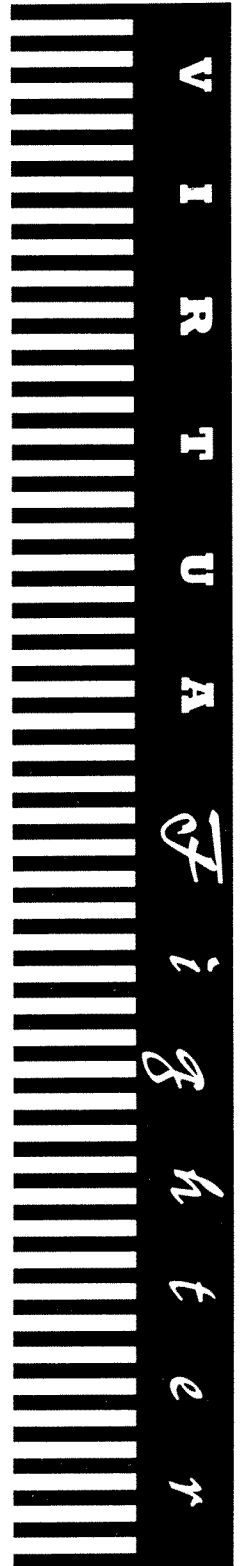

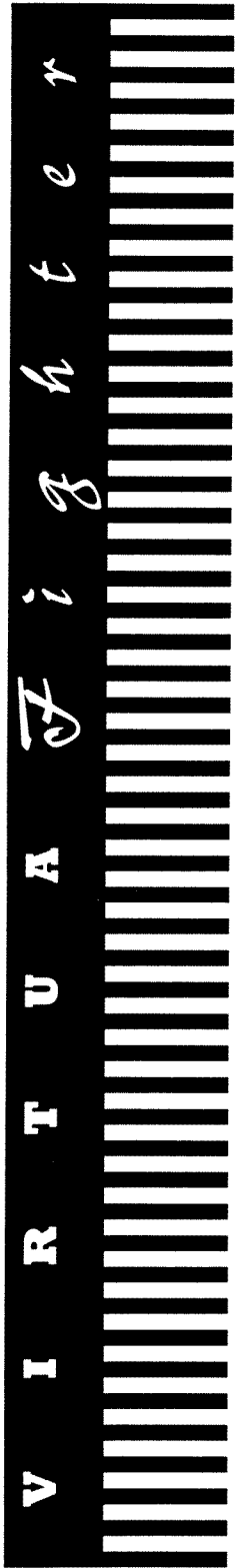

INPUT TEST

This test displays the state of each switch. If the switch goes ON when activated, it is satisfactory.

| INPUT TEST | | | |
|--------------------------|---|-----|-----|
| PLAYER | | 1P | 2P |
| UP | : | OFF | OFF |
| DOWN | : | OFF | OFF |
| RIGHT | : | OFF | OFF |
| LEFT | : | OFF | OFF |
| | | | |
| PUNCH | : | OFF | OFF |
| KICK | : | OFF | OFF |
| GUARD | : | OFF | OFF |
| | | | |
| START | : | OFF | OFF |
| | | | |
| COIN CHUTE 1 | : | OFF | |
| COIN CHUTE 2 | : | OFF | |
| SERVICE SW | | OFF | |
| TEST SW | | OFF | |
| | | | |
| PUSH TEST BUTTON TO EXIT | | | |

PUNCHSW1

KICKSW2

GUARDSW3

Push the Test Button to have the Menu return on to the screen.





CRT TEST

RGB COLOR ADJUSTMENT SCREEN

This page allows for checking the monitor color.

CRT TEST 1/2

| |
|-------|
| RED |
| GREEN |
| BLUE |
| WHITE |

PUSH TEST BUTTON TO CONTINUE

Each of the R(ed), G(reen), and B(lue) colors is most dark at the left-hand end and becomes brighter in 31 gradations towards the right-hand end. The monitor brightness is satisfactory if the white color bar is black at the left-hand end and white at the right-hand end. Pressing the Test button causes the screen to proceed to the next page.



C DIFFICULTY

Sets the game's overall difficulty (EASY to HARDEST). Set to NORMAL in standard setting.

D ADVERTISE SOUND

Determines whether ADVERTISE SOUND is to be emitted or not. Set to ON in the standard setting.

E CONTINUE

This sets CONTINUE play YES or NO. Set to ON for Yes, and OFF for NO. Standard setting is ON.

F COUNTRY

Message language. Select USA for the United States, JAPAN for Japan, and EXPORT for other countries.

G CABINET TYPE

Two types of cabinets (SUPER MEGALO or ASTRO CITY 2. are available. VIRTUA FIGHTER uses ASTRO CITY 2. Depending on which one is utilized, the contents of DIFFICULTY are different from each other. At the time of shipment, the CABINET TYPE is set to either one in a manner to correspond to the actual cabinet used.

H INITIAL

Initializes GAME ASSIGNMENT except for COUNTRY and CABINET TYPE.

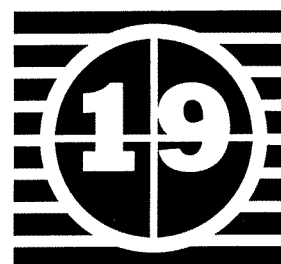

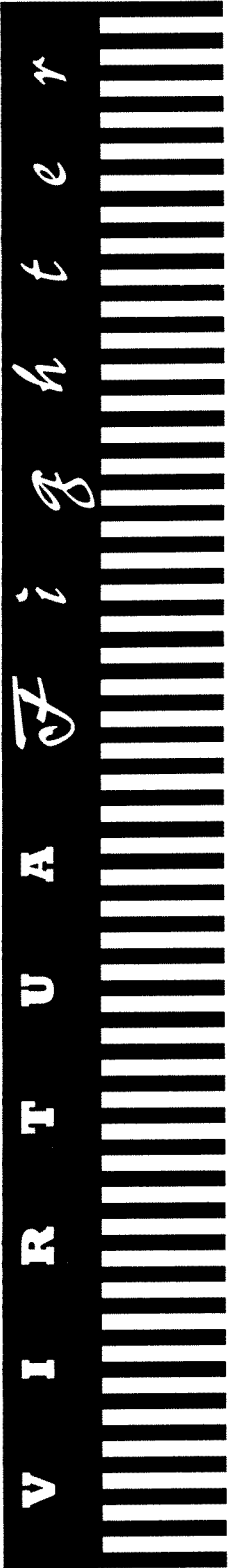

C OIN ASSIGNMENTS

In this mode, the COIN/CREDIT setting, etc. can be changed.

SELECTION OF DESIRED ITEM

- 1) Press the Service Button to choose the setting item. The red characters indicate the presently selected item.
- 2) Press the Test Button to change the setting.
- 3) To cause change to take effect, use Service Button to select EXIT, then press Test Button

| | |
|--|-----------------|
| COIN ASSIGNMENT | |
| CREDIT TO START | 2 CREDITS |
| CREDIT TO CONTINUE | 2 CREDITS |
| | |
| COIN/CREDIT SETTING | #1 |
| COIN CHUTE #1 | 1 COIN 1 CREDIT |
| COIN CHUTE #2 | 1 COIN 1 CREDIT |
| | |
| MANUAL SETTING | |
| EXIT | |
| SELECT BY SERVICE BUTTON AND PUSH TEST BUTTON | |

A CREDIT TO START/CREDIT TO CONTINUE

Sets the credits required for starting the game and credits required for continuing.

CREDIT TO START can be set 1 to 5

CREDIT TO CONTINUE can be set 1 to 5

B COIN CREDIT SETTING

Sets the CREDIT increase increment per coin insertion. There are 26 settings from 1 to 26,

expressed in 00 CREDIT as against 00 COINS

inserted. #26 refers to FREE PLAY (Setting #1 is the standard setting. See Table 1-2.



C MANUAL SETTING

The CREDIT's incremental increase settings as against a coin insertion are shown in further detail in Table 3. Also, note that when this MANUAL SETTING is performed, the COIN/CREDIT setting becomes ineffective.

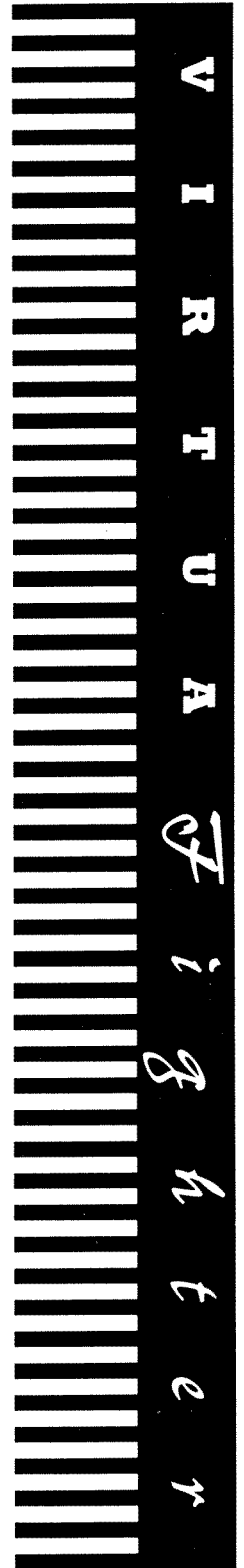

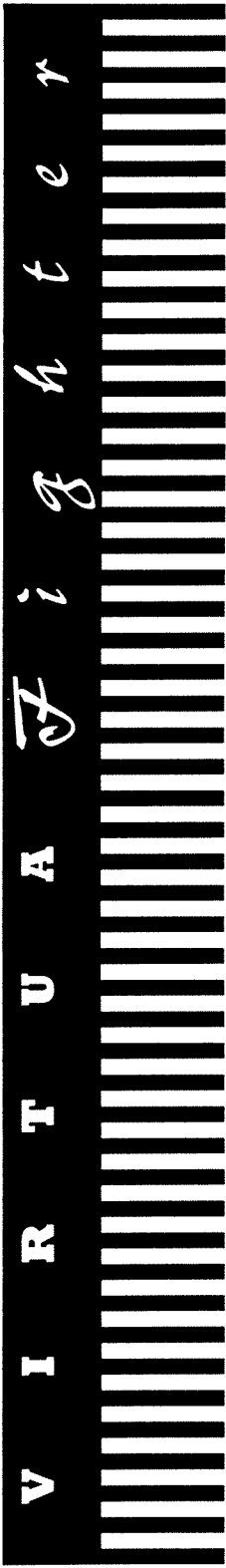

T TABLE 1: COIN/CREDIT SETTING

| Name of Setting | Coin Chute 1 | Coin Chute 2 |
|-----------------|--|--|
| Setting #1 | 1 Coin 1 Credit | 1 Coin 1 Credit |
| Setting #2 | 1 Coin 1 Credit | 1 Coin 2 Credits |
| Setting #3 | 1 Coin 1 Credit | 1 Coin 3 Credits |
| Setting #4 | 1 Coin 1 Credit | 1 Coin 4 Credits |
| Setting #5 | 1 Coin 1 Credit | 1 Coin 5 Credits |
| Setting #6 | 1 Coin 2 Credits | 1 Coin 2 Credits |
| Setting #7 | 1 Coin 2 Credits | 1 Coin 5 Credits |
| Setting #8 | 1 Coin 3 Credits | 1 Coin 3 Credits |
| Setting #9 | 1 Coin 4 Credits | 1 Coin 4 Credits |
| Setting #10 | 1 Coin 5 Credits | 1 Coin 5 Credits |
| Setting #11 | 1 Coin 6 Credits | 1 Coin 6 Credits |
| Setting #12 | 2 Coins 1 Credit | 2 Coins 1 Credit |
| Setting #13 | 2 Coins 1 Credit | 1 Coin 1 Credit |
| Setting #14 | 2 Coins 1 Credit | 1 Coin 2 Credits |
| Setting #15 | 1 Coin 1 Credit 2 Coins 3 Credits | 1 Coin 1 Credit 2 Coins 3 Credits |
| Setting #16 | 1 Coin 1 Credit 2 Coins 3 Credits | 1 Coin 3 Credits |
| Setting #17 | 3 Coins 1 Credit | 3 Coins 1 Credit |
| Setting #18 | 4 Coins 1 Credit | 4 Coins 1 Credit |
| Setting #19 | 1 Coin 1 Credit 2 Coins 2 Credits 3 Coins 3 Credits 4 Coins 5 Credits | 1 Coin 1 Credit 2 Coins 2 Credits 3 Coins 3 Credits 4 Coins 5 Credits |
| Setting #20 | 1 Coin 1 Credit 2 Coins 2 Credits 3 Coins 3 Credits 4 Coins 5 Credits | 1 Coin 5 Credits |



T

TABLE 2: COIN/CREDIT SETTING

| Name of Setting | Coin Chute 1 | Coin Chute 2 |
|-----------------|---|---|
| Setting #21 | 3 Coins 1 Credit 5 Coins 2 Credits | 1 Coin 2 Credits |
| Setting #22 | 2 Coins 1 Credit 4 Coins 2 Credits 5 Coins 3 Credits | 2 Coins 1 Credit 4 Coins 2 Credits 5 Coins 3 Credits |
| Setting #23 | 2 Coins 1 Credit 4 Coins 2 Credits 5 Coins 3 Credits | 1 Coin 3 Credits |
| Setting #24 | 1 Coin 1 Credit 2 Coins 2 Credits 3 Coins 3 Credits 4 Coins 4 Credits 5 Coins 6 Credits | 1 Coin 1 Credit 2 Coins 2 Credits 3 Coins 3 Credits 4 Coins 4 Credits 5 Coins 6 Credits |
| Setting #25 | 1 Coin 1 Credit 2 Coins 2 Credits 3 Coins 3 Credits 4 Coins 4 Credits 5 Coins 6 Credits | 1 Coin 6 Credits |
| Setting #26 | Free Play | Free Play |

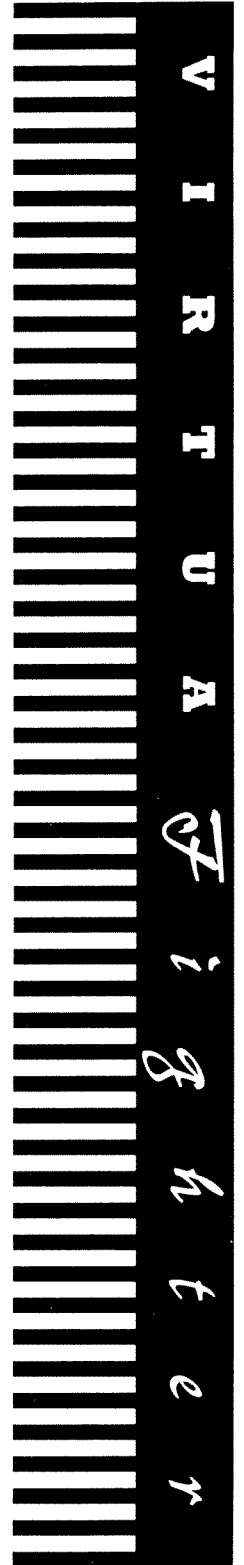

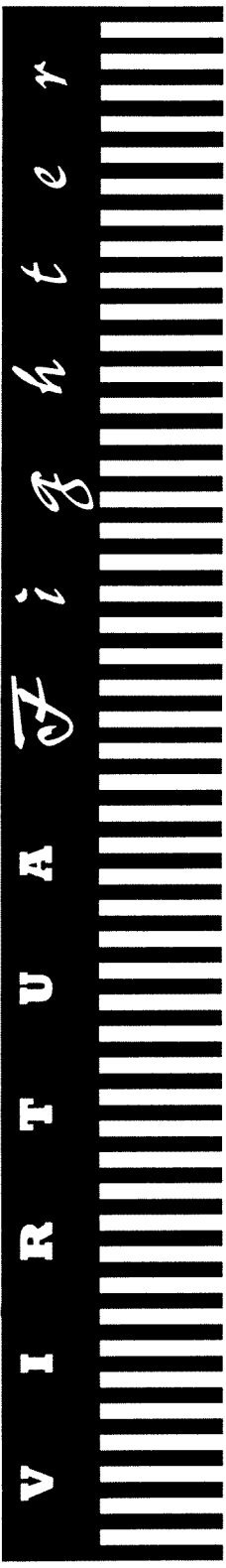

T TABLE 3: MANUAL SETTING

| | | |
|-----------------------|---------|----------|
| Coin To Credit | 1 Coin | 1 Credit |
| | 2 Coins | 1 Credit |
| | 3 Coins | 1 Credit |
| | 4 Coins | 1 Credit |
| | 5 Coins | 1 Credit |
| | 6 Coins | 1 Credit |
| | 7 Coins | 1 Credit |
| | 8 Coins | 1 Credit |
| | 9 Coins | 1 Credit |

| | |
|--------------------|---------------------------|
| Bonus Adder | No Bonus Adder |
| | 2 Coins Give 1 Extra Coin |
| | 3 Coins Give 1 Extra Coin |
| | 4 Coins Give 1 Extra Coin |
| | 5 Coins Give 1 Extra Coin |
| | 6 Coins Give 1 Extra Coin |
| | 7 Coins Give 1 Extra Coin |
| | 8 Coins Give 1 Extra Coin |
| | 9 Coins Give 1 Extra Coin |

| | |
|-------------------------------------|--------------------------|
| Coin Chute #1 Multiplier | 1 Coin Counts As 1 Coin |
| | 1 Coin Counts As 2 Coins |
| | 1 Coin Counts As 3 Coins |
| | 1 Coin Counts As 4 Coins |
| | 1 Coin Counts As 5 Coins |
| | 1 Coin Counts As 6 Coins |
| | 1 Coin Counts As 7 Coins |
| | 1 Coin Counts As 8 Coins |
| | 1 Coin Counts As 9 Coins |



| | |
|-------------------------------------|--------------------------|
| Coin Chute #2 Multiplier | 1 Coin Counts As 1 Coin |
| | 1 Coin Counts As 2 Coins |
| | 1 Coin Counts As 3 Coins |
| | 1 Coin Counts As 4 Coins |
| | 1 Coin Counts As 5 Coins |
| | 1 Coin Counts As 6 Coins |
| | 1 Coin Counts As 7 Coins |
| | 1 Coin Counts As 8 Coins |
| | 1 Coin Counts As 9 Coins |

EXAMPLES FOR THE CALCULATION OF CREDITS SET IN THE "MANUAL" SETTING

Example 1

COIN TO CREDIT = 4 COINS, 1 CREDIT

BONUS ADDER = 2 COINS GIVE 1 EXTRA COIN

COIN CHUTE MULTIPLIER = 1 COIN COUNTS AS 2 COINS

In the above setting, when 7 coins are inserted in the 1P COIN CHUTE, the number of 1P credits will be as follows:

- 1) As per the COIN CHUTE MULTIPLIER setting, since 1 coin inserted counts as 2 coins, 7 coins inserted will be equivalent to 14 coins.
- 2) According to the BONUS ADDER setting, every 2 coins earn one service coin, therefore, the equivalent of 14 coins will have 7 service coins added, resulting in the equivalent of 21 coins.
- 3) According to the COIN TO CREDIT setting, 4 coins make 1 credit, therefore, the equivalent of 21 coins makes 5-1/4 credits.

Example 2

COIN TO CREDIT = 6 COINS, 1 CREDIT

BONUS ADDER = 3 COINS GIVE 1 EXTRA COIN

COIN CHUTE #1 MULTIPLIER = 1 COIN COUNTS AS 4 COINS

COIN CHUTE #2 MULTIPLIER = 1 COIN COUNTS AS 5 COINS

In the above setting, when 3 coins are inserted into COIN CHUTE #1 and 5 coins into COIN CHUTE #2, the number of credits will be as follows:

- 1) According to COIN CHUTE #1 MULTIPLIER setting, one coin inserted counts as 4 coins, therefore, 3 coins are equivalent to 12 coins.
- 2) According to the COIN CHUTE #2 MULTIPLIER setting, one coin inserted counts as 5 coins, therefore, 5 coins inserted into COIN CHUTE #2 will be equivalent to 25 coins.
- 3) The total number of coins in COIN CHUTE #1 and #2 will be equivalent to 37 coins.
- 4) According to BONUS ADDER setting, every 3 coins will earn one service coin, therefore, the equivalent of 37 coins with 12 service coins added will be equivalent to 49 coins.
- 5) According to the COIN TO CREDIT setting, 6 coins make 1 CREDIT, therefore, the equivalent of 49 coins equals 8-1/6 credits.

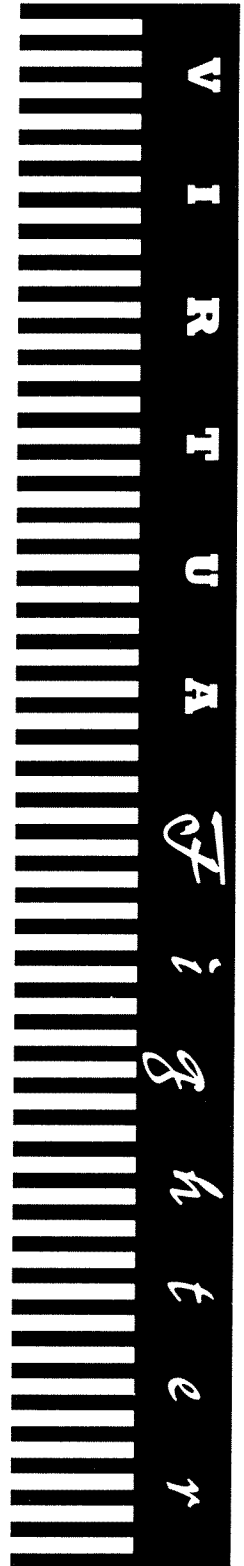



BOOKKEEPING

This test mode allows each of the CREDIT/TIME/GAME data to be ascertained.

1. GLOBAL DATA DISPLAY

| BOOKKEEPING 1/3 GLOBAL DATA | | | |
|---------------------------------|-----|-----|------|
| COIN CHUTE #1 | | | 00 |
| COIN CHUTE #2 | | | 00 |
| TOTAL COINS | | | 00 |
| COIN CREDITS | | | 00 |
| SERVICE CREDITS | | | 00 |
| TOTAL CREDITS | | | 00 |
| TOTAL TIME | 00D | 00H | 00S] |
| PLAY TIME RATIO (*1000) | | | 00 |
| TOTAL GAME COUNT (TIMES) | | | 00 |
| 1P GAME COUNT (TIMES) | | | 00 |
| 2P GAME COUNT (TIMES) | | | 00 |
| TOTAL AVERAGE TIME | 00M | | 00S |
| 1P AVERAGE TIME | 00M | | 00S |
| 2P AVERAGE TIME | 00M | | 00S |
| PUSH SERVICE BUTTON TO CONTINUE | | | |

- A COIN CHUTE #1 AND #2**
Number of times each Coin Chute is actuated.
- B TOTAL COIN**
Total number of times both the Coin Chutes are actuated.
- C COIN CREDIT**
Number of CREDITS registered by Coin insertion only.
- D SERVICE CREDIT**
The Service Switch usage frequency.
- E TOTAL CREDIT**
Total number of CREDITS.
- F TOTAL TIME**
Machine's total actuated time (excluding the test performance time).



G PLAY TIME RATIO

Displays the ratio of play time as against the total POWER--ON time.

H TOTAL GAME COUNT

Total game play time.

I 1P GAME COUNT

Displays the 1P play frequency.

J 2P GAME COUNT

Displays the 2P (Player vs. Player) play frequency.

K TOTAL AVERAGE TIME

Average game playtime.

L 1P AVERAGE TIME

Displays the 1P play average time.

M 2P AVERAGE TIME

Displays the 2P (Player vs. Player) play average time.

Press the Service Button to proceed to the next page.
Press the Test Button to have the Menu return on to the screen.



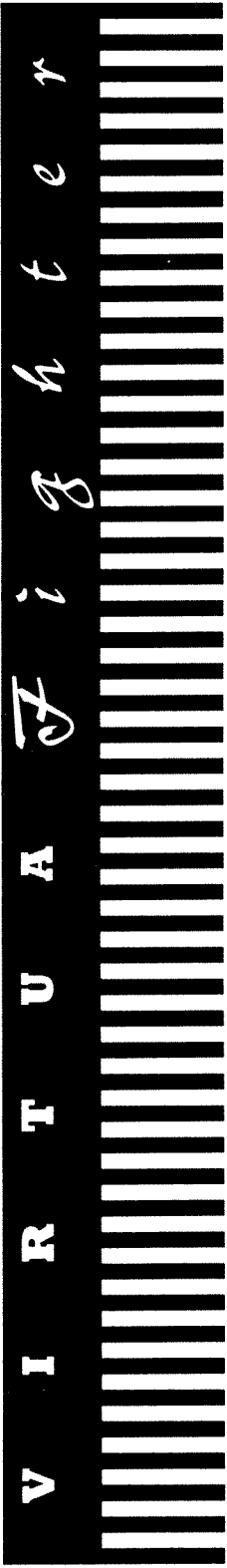

B BOOKKEEPING Continued

II. 1P GAME DATA DISPLAY

BOOKKEEPING 2/3 1P GAME DATA
SELECT BY PLAYER 1 SIDE LEVER (LEFT, RIGHT)

| | | | | |
|----------------|---------|-----|-----|-----|
| GAME COUNT | | | | 00 |
| TOTAL TIME | 00D | 00H | 00M | 00S |
| AVG. TIME | | | 00M | 00S |
| MIN. TIME | | | 00M | 00S |
| MAX. TIME | | | 00M | 00S |
| CONTINUE RATIO | (*1000) | | | 000 |
| DRAW | (*1000) | | | 000 |
| WIN BY KO | (*1000) | | | 000 |
| WIN BY RINGOUT | (*1000) | | | 000 |
| WIN BY JUDGE | (*1000) | | | 000 |

| ROUND | COUNT | TOTAL | AVG | SYOURITU |
|-------|----------|-------|-------|----------|
| (th) | (TIMERS) | (SEC) | (SEC) | (*1000) |
| 1 | 0 | 0 | 0 | 0 |
| 2 | 0 | 0 | 0 | 0 |
| 3 | 0 | 0 | 0 | 0 |
| 4 | 0 | 0 | 0 | 0 |
| 5 | 0 | 0 | 0 | 0 |
| 6 | 0 | 0 | 0 | 0 |
| 7 | 0 | 0 | 0 | 0 |
| 8 | 0 | 0 | 0 | 0 |

PUSH SERVICE BUTTON TO CONTINUE

- N GAME COUNT**
Displays 1P play frequencies.
- O TOTAL TIME**
Displays the total play time (1P side).
- P AVERAGE TIME**
Displays the average play time (1P side).
- Q MIN. TIME**
Displays the maximum play time (1P side).
- R MAX. TIME**
Displays the maximum play time (1P side).
- S CONTINUE RATIO**
Displays the continue play ratio (1P side).
- T DRAW**
Displays the draw ratio (1P side).



U WIN BY KO

Displays the ratio of winning by KNOCK OUT (1P side).

U WIN BY RINGOUT

Displays the ratio of winning by RING OUT (1P side).

U WIN BY JUDGE

Displays the ratio of winning by a decision (1P side).

Those other than the above show the per round play frequency/total play time/average play time/winning ratio as well as these data represented by bar graphs.

Try to move the "*" mark by moving the 1P side Lever to the left and right, and the bar graphs representing the data under the "*" mark will be displayed.

Press the Service Button to proceed to the next page. Press the Test Button to have the Menu return on to the screen.

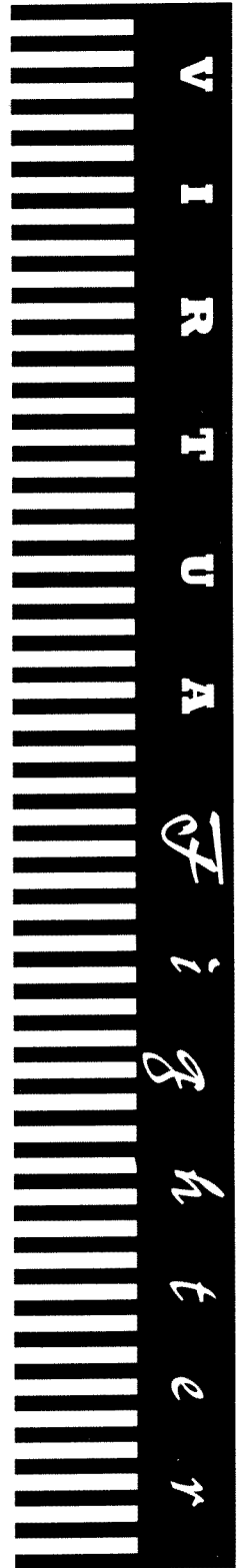

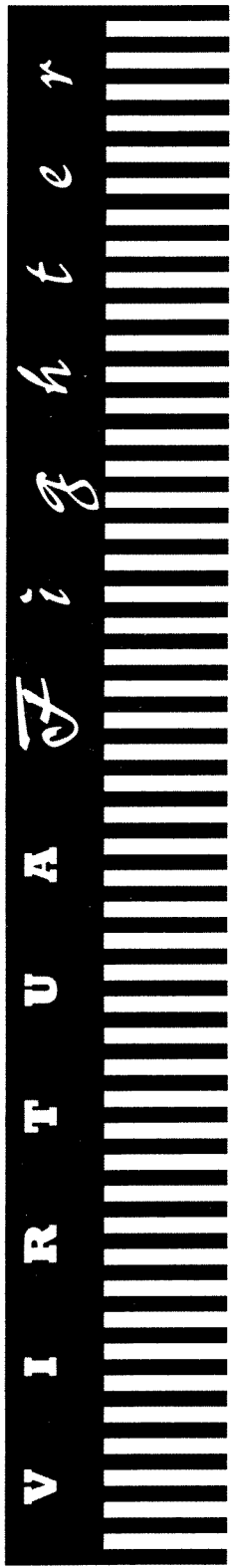

B BOOKKEEPING Continued

III. 2P GAME DATA DISPLAY

BOOKKEEPING 3/3 2P GAME DATA
SELECT BY PLAYER 1 SIDE LEVER (LEFT, RIGHT)

| GAME COUNT | | | 00 | | | |
|----------------|---------|-----|---------|-----------|---|---------|
| TOTAL TIME | 00D 00H | 00M | 00S | TIME BAND | | RATIO |
| AVG. TIME | | | 00M 00S | (SEC) | | (TIMES) |
| MIN. TIME | | | 00M 00S | 10 | — | 0 |
| MAX. TIME | | | 00M 00S | 13 | — | 0 |
| CONTINUE RATIO | (*1000) | 000 | | 16 | — | 0 |
| DRAW | (*1000) | 000 | | 19 | — | 0 |
| WIN BY KO | (*1000) | 000 | | 22 | — | 0 |
| WIN BY RINGOUT | (*1000) | 000 | | 25 | — | 0 |
| WIN BY JUDGE | (*1000) | 000 | | 28 | — | 0 |
| | | | | 31 | — | 0 |
| | | | | 34 | — | 0 |
| | | | | 37 | — | 0 |
| | | | | 40 | — | 0 |
| | | | | 43 | — | 0 |
| | | | | 46 | — | 0 |
| | | | | 49 | — | 0 |
| | | | | 52 | — | 0 |
| | | | | 55 | — | 0 |
| | | | | 58 | — | 0 |
| | | | | 61 | — | 0 |
| | | | | 64 | — | 0 |
| | | | | 67 | — | 0 |
| | | | | 70 | — | 0 |
| | | | | 73 | — | 0 |
| | | | | 76 | — | 0 |
| | | | | 79 | — | 0 |
| | | | | 82 | — | 0 |
| | | | | 85 | — | 0 |
| | | | | 88 | — | 0 |
| | | | | 91 | — | 0 |
| | | | | 94 | — | 0 |
| | | | | 97 | — | 0 |
| | | | | 100 | — | 0 |
| | | | | 103 | — | 0 |

PUSH SERVICE BUTTON TO CONTINUE

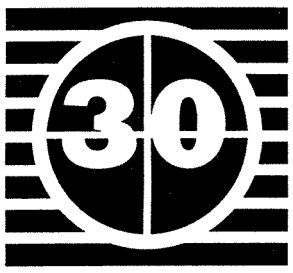

X GAME COUNT

Displays Players vs. Player play frequencies.

Y TOTAL TIME

Displays the total play time (Player vs. Player).

Z AVG. TIME

Displays the average play time (Player vs. Player).

a MIN. TIME

Displays the minimum play time (Player vs. Player).

b MAX. TIME

Displays the maximum play time (Player vs. Player).

c CONTINUE RATIO

In the case of Player vs. Player (2P) play, when the CONTINUE function is ON and where the CREDIT TO START and CREDIT TO CONTINUE are different in value, the 2P play can be CONTINUED. The CONTINUE RATIO shows the ratio of 2P plays CONTINUED.

d DRAW

Displays the draw ratio (Player vs. Player).

e WIN BY KO

Displays the ratio of winning by KNOCK OUT (Player vs. Player).

f WIN BY RINGOUT

Displays the ratio of winning by RING OUT (Player vs. Player).

e WIN BY JUDGE

Displays the ratio of winning by a decision (Player vs. Player).

Those other than the above show the per play playtime bookkeeping represented in bar graphs. Refer to these as a standard when setting the DIFFICULTY, etc.

Press the Service Button to proceed to the next page.
Press the Test Button to have the Menu return on to the screen.

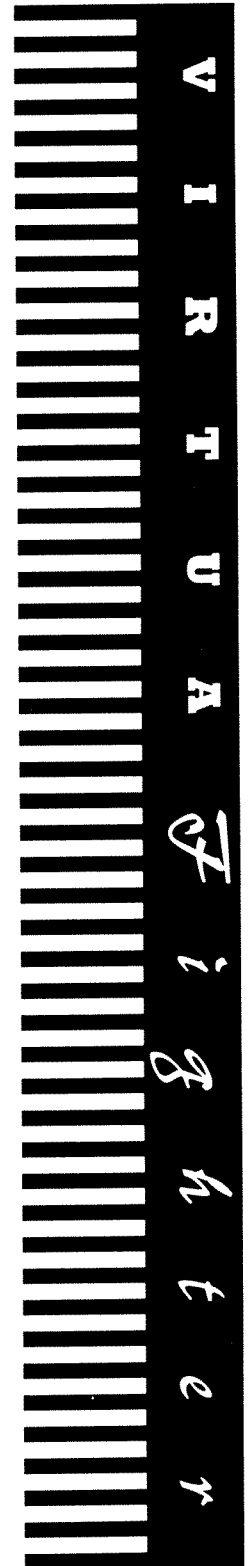

BACKUP DATA CLEAR

Clears the contents of BOOKKEEPING

BACKUP RAM CLEAR

* YES (CLEAR)
NO (CANCEL)

SELECT BY SERVICE BUTTON
AND PUSH TEST BUTTON

When clearing, bring "*" to YES and when not clearing, to NO, by using the Service Switch, and then push the Test Button.

When clearing has been finished, COMPLETED will be displayed.

Pressing the Test Button will have the Menu return on to the screen.

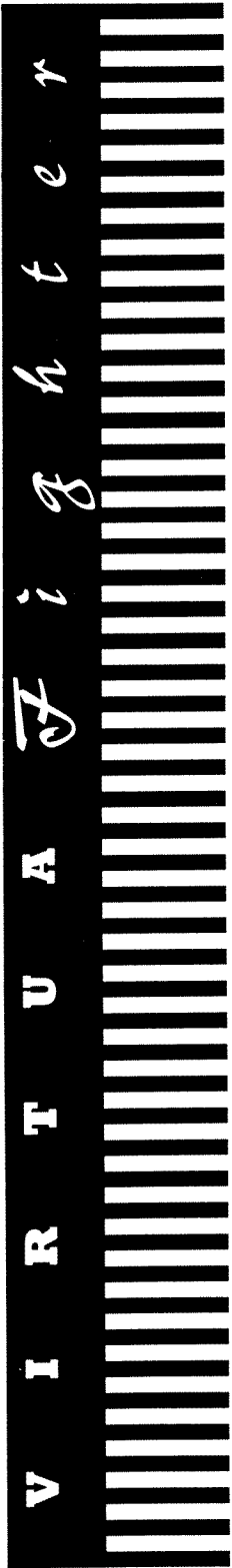

TGP TEST

In this test, the TGP (the onscreen display-related IC) is checked. GOOD is displayed for normal ICs.

| TGP TEST | | |
|----------|------|------|
| IC 57 | GOOD | GOOD |
| IC 58 | GOOD | GOOD |
| IC 60 | GOOD | GOOD |
| IC 66 | GOOD | GOOD |

Five seconds after the test is started, pressing the Test Button causes the Menu to return on to the screen.



V
I
R
T
U
A
F
i
g
h
t
e
r



GAME BOARD ASSEMBLY

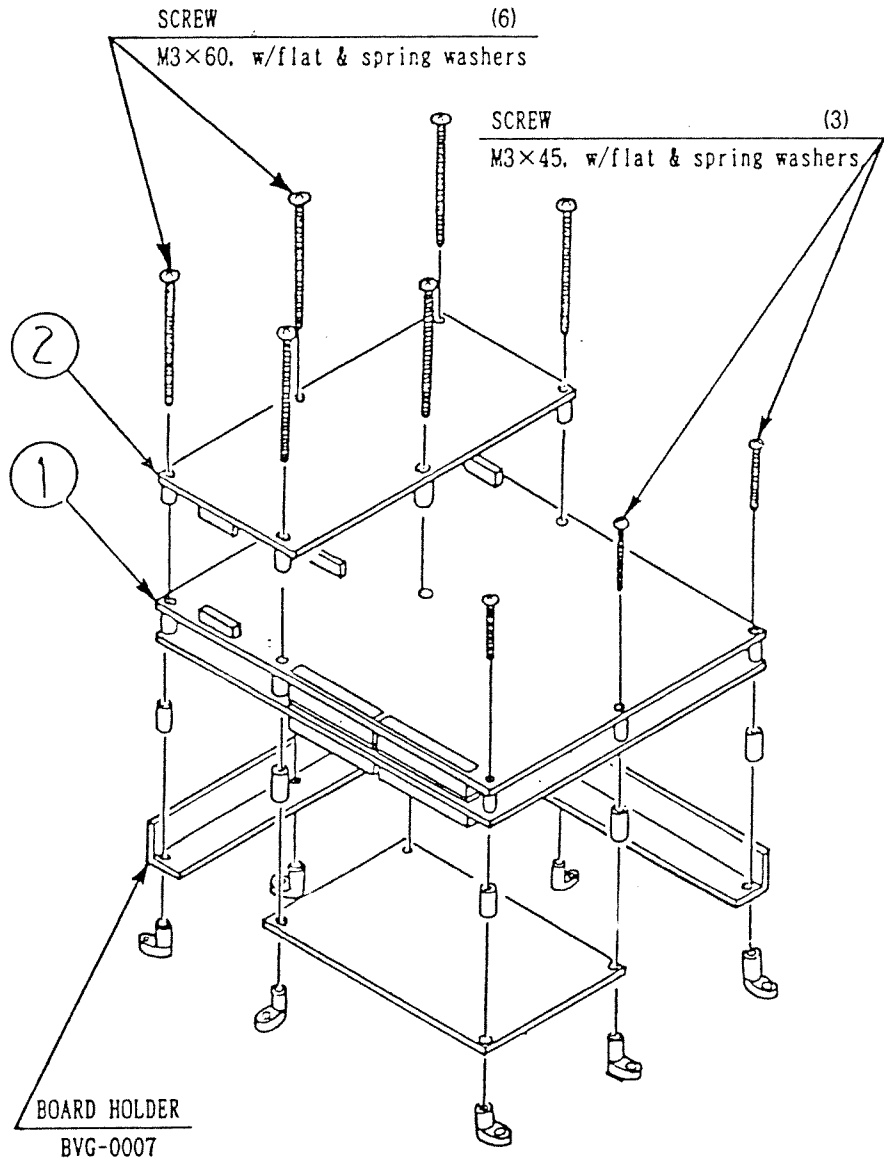

| No. | Part No. | Description |
|-----|--------------------|---------------------------------------|
| -- | 833-10016 | Game Board VIRTUA FIGHTER |
| 1 | 837-10015 | CPU Board Model-1 COM(FGT) |
| 2 | 834-10170 | ROM Board VIRTUA FIGHTER |
| | Commonly Available | Screw M3 x 45 w/flat & spring washers |
| | BVG--0007 | Board Holder |
| | Commonly Available | Screw M3 x 60 w/flat & spring washers |



S HIELD CASE ASSEMBLY

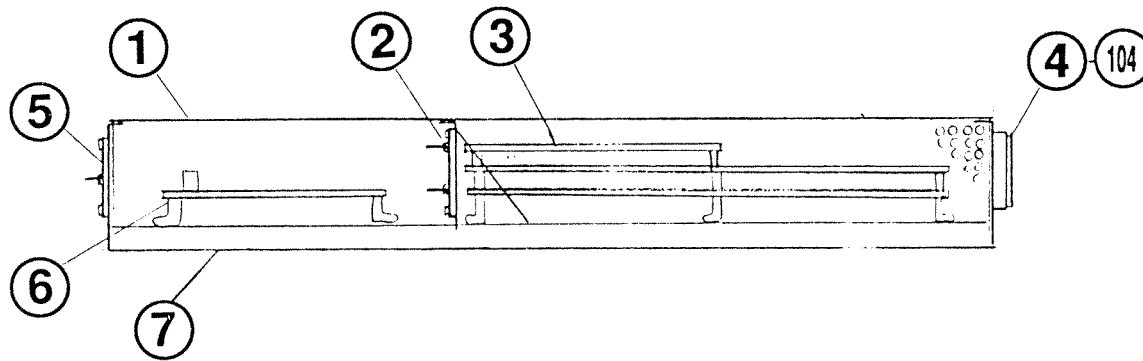

| No. | Part No. | Description |
|-----|---------------|-------------------------------|
| 1 | S115-1266-000 | Cage Cover |
| 2 | 839-0630 | CPU Connector Board |
| 3 | 833-10016 | CPU Logic PC |
| 4 | | 12VDC Fan (92mm, 40 CFM min.) |
| 5 | 839-0629 | Filter Board |
| 6 | 837-8936 | I/O Board |
| 7 | S115-019-000 | Cage Base |
| 104 | | Fan Guard |



V
I
R
T
U
A
L
I
G
H
T
E
R

F LUORESCENT LAMP (VF)

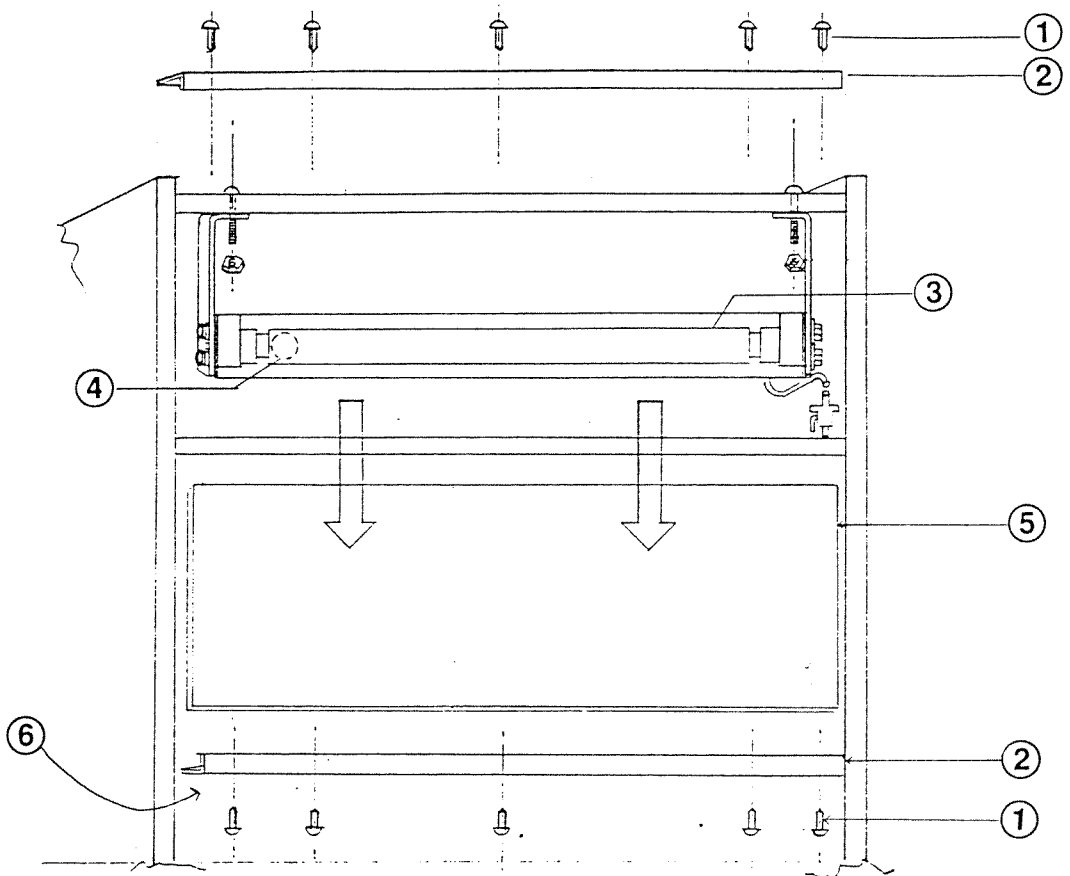

| No. | Part No. | Description |
|-----|--------------------|------------------------------------|
| 1 | 0005-231-211 | #8 X 1/8" Black Pan Head Screw |
| 2 | 0065-037-002 | Header Retainer Bracket |
| 3 | Commonly Available | 24" Fluorescent Lamp (F20 T 12/CW) |
| 4 | Commonly Available | Starter (FS-2 20W) |
| 5 | 999-0201 | Header Marquee Glass |
| 6 | 999-0202 | Monitor Glass |



CONTROL PANEL (VF)

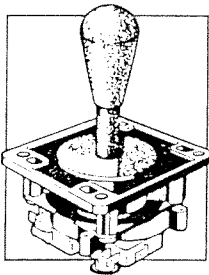
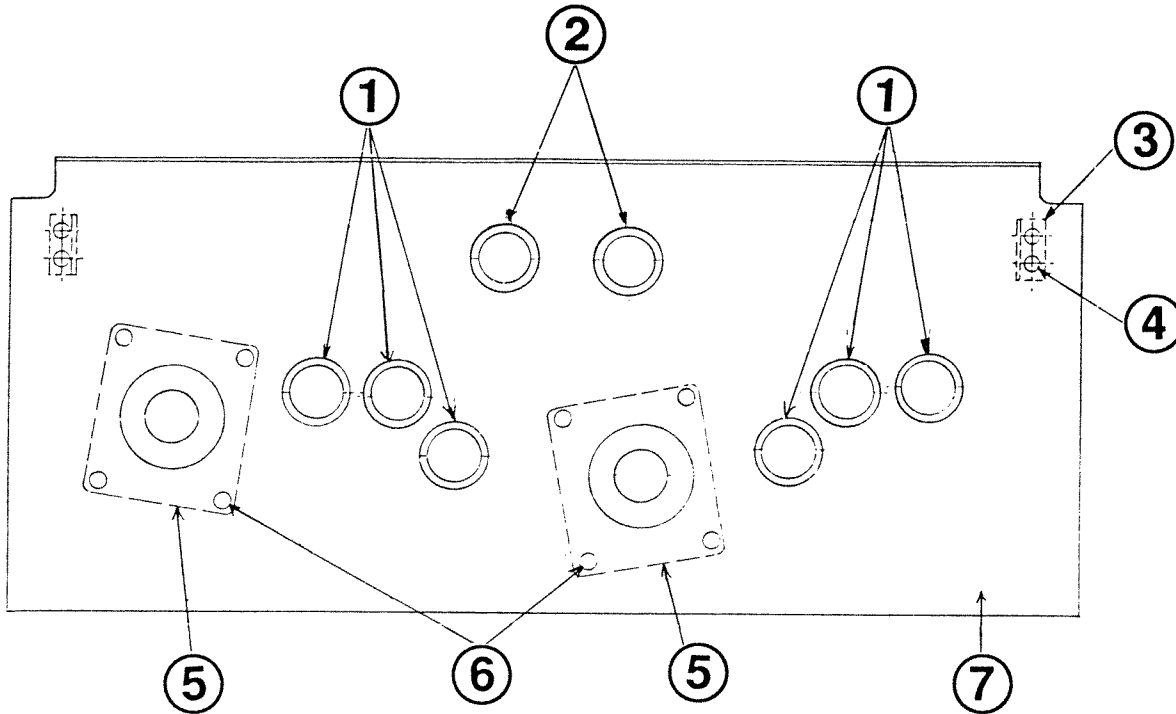

Typical Joystick Assembly

Typical Switch Assembly

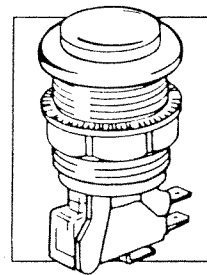

| No. | Part No. | Description |
|-----|--------------|------------------------------------|
| 1 | 999-0212 | Push Button Assembly (Red) |
| 2 | 999-0213 | Start Push Button Assembly (White) |
| 3 | 0069-006-000 | Strike Bracket (2) |
| 4 | 0007-183-211 | Carriage Bolt (4) |
| 5 | 999-0214 | Joystick Assembly (2) |
| 6 | 0007-001-111 | Carriage Bolt (8) |
| 7 | 999-0200 | Lexan Overlay |

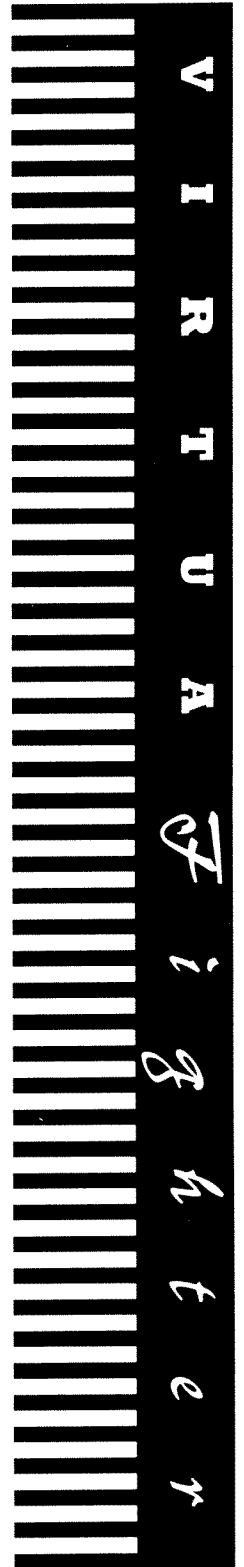



S WITCH BRACKET ASSEMBLY

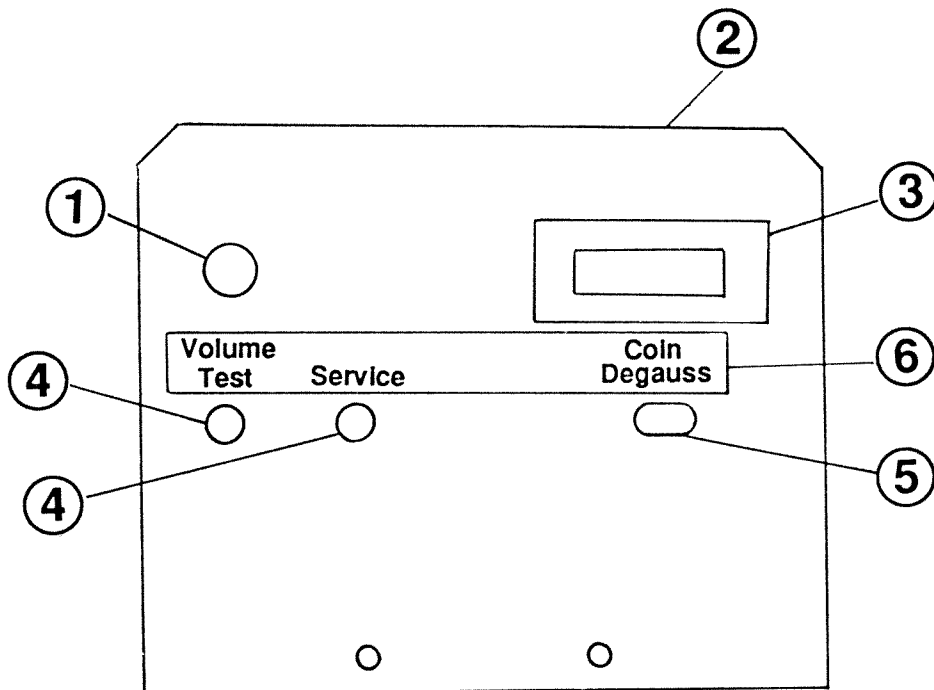

| No. | Part No. | Description |
|-----|----------|---------------------------------------|
| 1 | | 5k Volume Pot |
| 2 | | Bracket |
| 3 | | Coin Meter (6VDC, No Diode, No Light) |
| 4 | | Push Button Switch |
| 5 | | 3A Push Button Switch |
| 6 | | Label |

SOUND BOARD ASSEMBLY

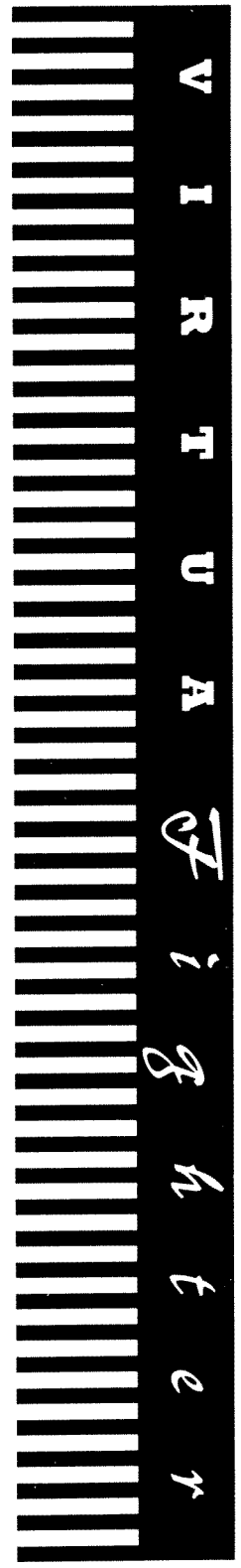
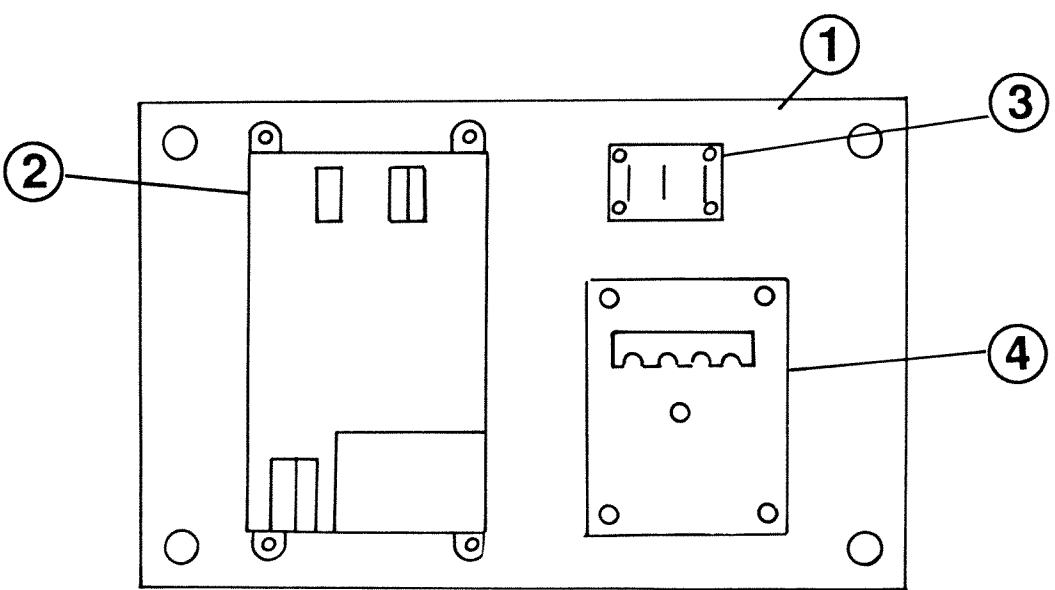

| No. | Part No. | Description |
|-----|-----------|--------------|
| 1 | | Wood Base |
| 2 | 837-8679 | Sound Board |
| 3 | 839-0542 | Mixer PC |
| 4 | 838-10018 | Audio Amp PC |



V I R T U A F i g h t e r

P POWER UNIT ASSEMBLY

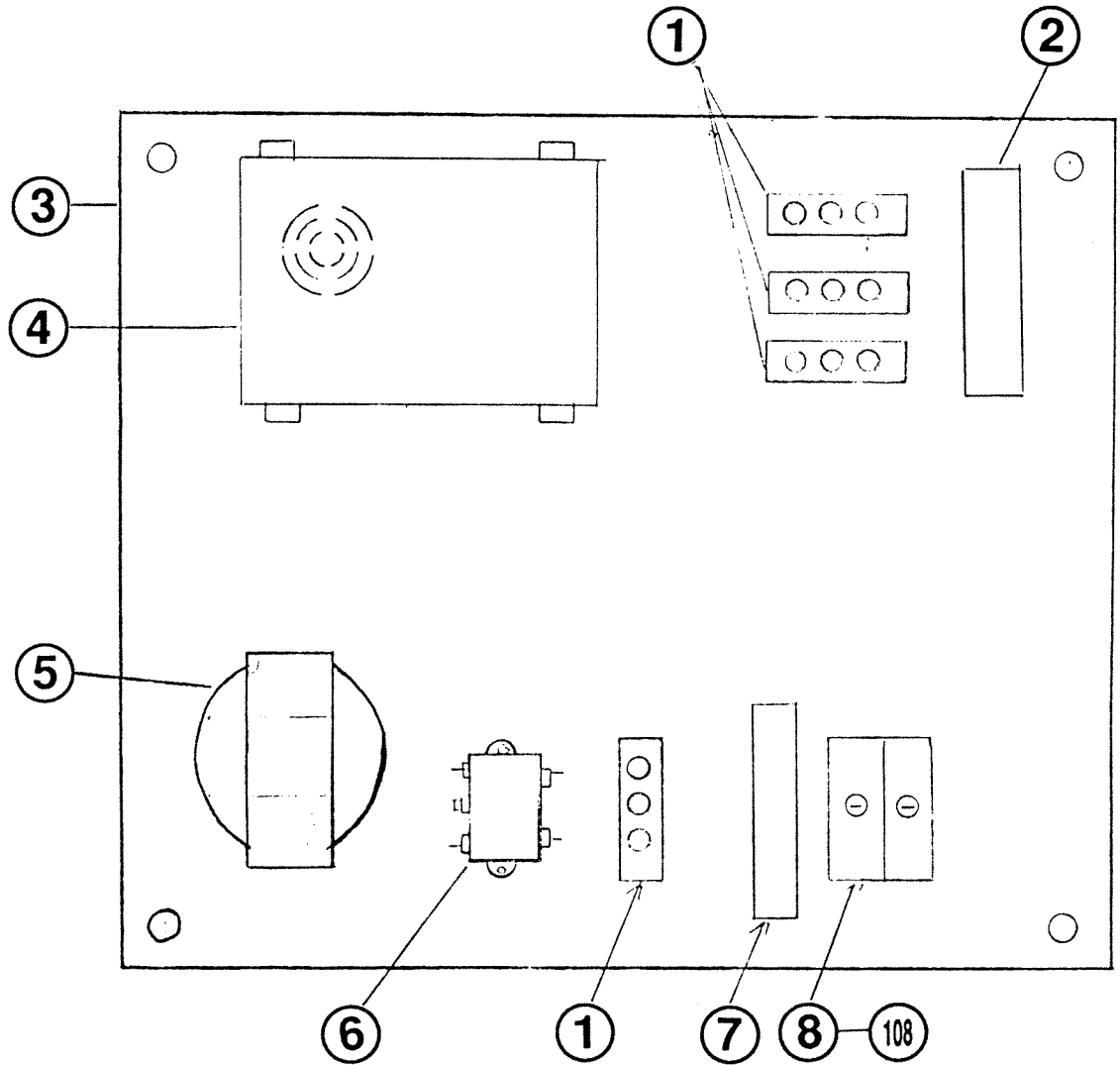

| No. | Part No. | Description |
|-----|----------|----------------------------|
| 1 | | Commutation Bracket (4) |
| 2 | | Label |
| 3 | | Wood Base |
| 4 | 999-0102 | 150W Power Supply |
| 5 | 999-0205 | Virtua Fighter Transformer |
| 6 | | Line Filter |
| 7 | | Fuse Label |
| 8 | | Fuse Holder |
| 108 | | Fuse 5A |



WIRE COLOR CODE TABLE

The Wire Color Code is as follows:

| | |
|---|-------------|
| A | Pink |
| B | Sky Blue |
| C | Brown |
| D | Purple |
| E | Light Green |

Wires other than those of any of the above 5 single colors will be displayed by 2 alphanumeric characters:

| | |
|---|--------|
| 1 | Red |
| 2 | Blue |
| 3 | Yellow |
| 4 | Green |
| 5 | White |
| 7 | Orange |
| 8 | Black |
| 9 | Gray |

If the right-hand side numeral of the code is 0, then the wire will be of a single color shown by the left-hand side numeral (see list above).

If the right-hand side alphanumeric is not 0, that particular wire has a spiral color code. The left-hand side character shows the base color and the right-hand side one shows the spiral color.

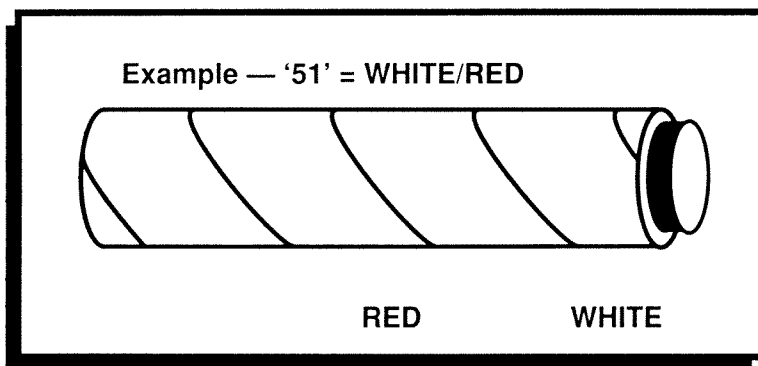

The character following the wire color code indicates the size of the wire:

| | | |
|------|----------|----------|
| K | A W G 18 | U L 1015 |
| L | A W G 20 | U L 1007 |
| None | A W G 22 | U L 1007 |

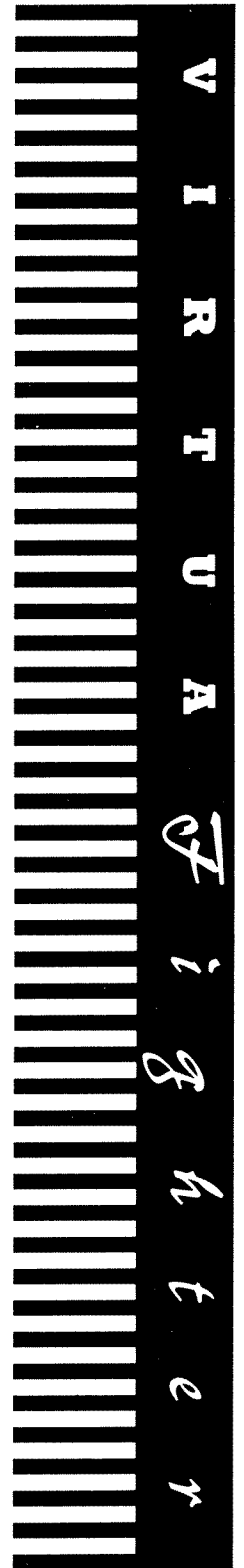

SEGA VIRTUA FIGHTER UPRIGHT GAME

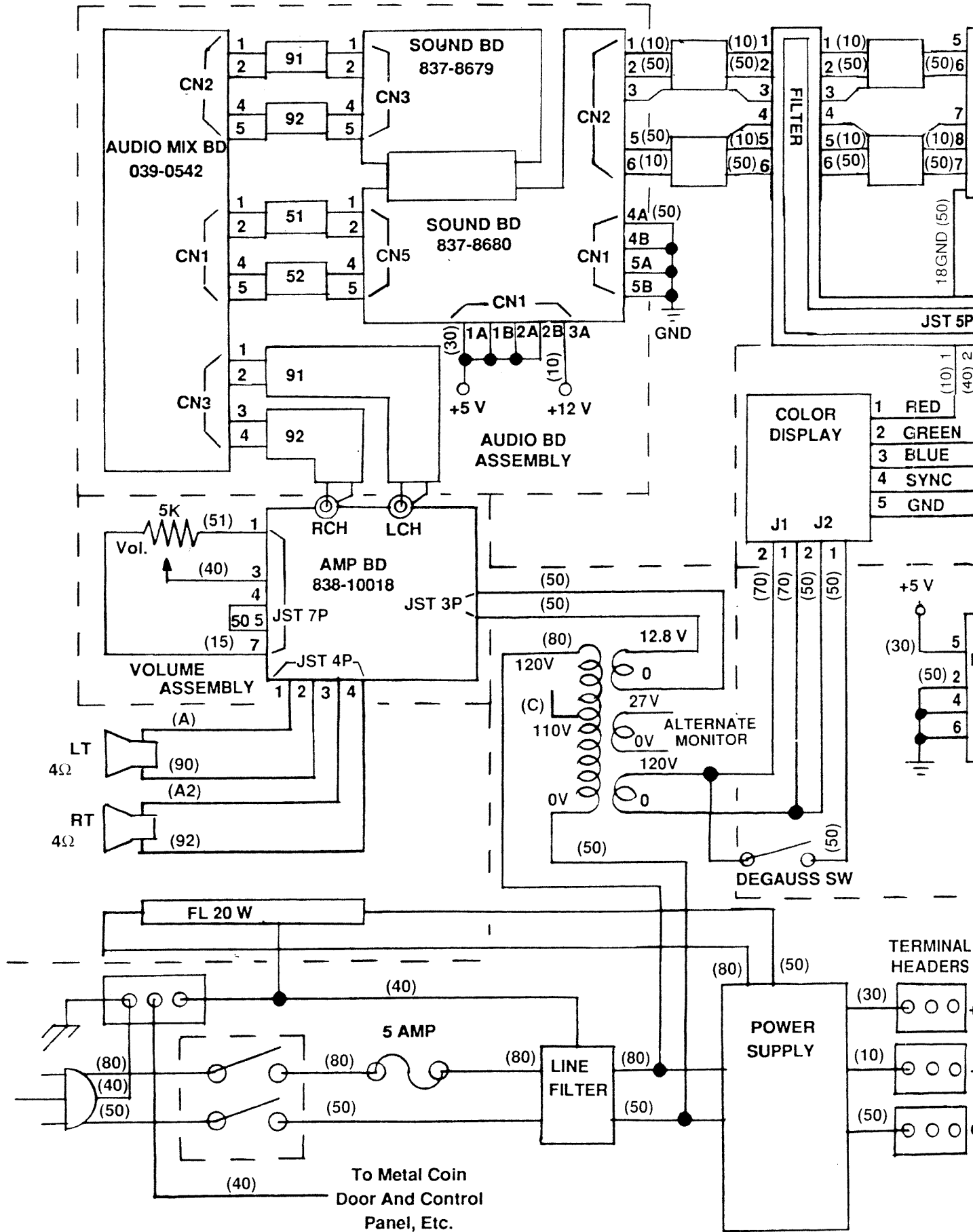

ME WIRING

