



# MANUAL

## WARNING

This game is for use in the United States of America and Canada. Sales, export or operation outside of these countries may be construed as copyright and trademark infringements and is strictly prohibited. Violators are subject to severe penalties and will be prosecuted to the full extent of the law.

**CAPCOM®**



## **WARNING**

**THIS GAME MUST BE GROUNDED. FAILURE TO DO SO MAY RESULT IN DESTRUCTION TO ELECTRONIC COMPONENTS.**

**WARNING:** This equipment generates, uses and can radiate radio frequency energy and if not used in accordance with the instruction manual, may cause interference to radio communication. It has been tested and found to comply with the limits for a CLASS A computing device pursuant to SUBPART J and PART 15 of FCC RULES, which are designed to provide reasonable protection against such interference when operated in a commercial environment. Operation of this equipment in a residential area is likely to cause interference in which case the user at his own expense will be required to take whatever measures may be required to correct the interference.



**"WINNERS DON'T USE DRUGS"**

**Louis Freeh, Director, FBI**

• IN COOPERATION WITH THE AAMA AND FBI ANTI-DRUG CAMPAIGN •

# **CAPCOM**

## **INVITES YOU TO USE**

**OUR SERVICE NUMBER FOR  
SERVICE INFORMATION CONCERNING THIS GAME, OR ANY  
OTHER CAPCOM GAME YOU NOW HAVE ON LOCATION.  
PLEASE HAVE GAME SERIAL NUMBERS AND CABINET NUMBERS READY.**

**CALL US FOR PROMPT, COURTEOUS  
ANSWERS TO YOUR PROBLEMS.**

**DIRECT NUMBER 1-800-833-0190**

---

# CAUTION

---

Please keep the following instructions to keep the PC board in good condition

- Do not block the ventilation slots.
- Do not drop or bump the board.
- Do not spill any liquids on the case.
- Do not disassemble the case.

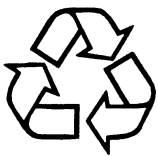

**Ni-cd**

#### ATTENTION

The product that you have purchased contains a rechargeable battery. The battery is recyclable. At the end of its useful life, under various state and local laws, it may be illegal to dispose of this battery into the municipal waste system. Check with your local solid waste official for details in your area for recycling options or proper disposal.

**DISASSEMBLING THE CASE OR REMOVING THE  
STICKER MAY CAUSE THE TERMINATION OF  
YOUR REPAIR WARRANTY.**

---

# PARTS LIST

There are two different kits available for Eco Fighter. The first kit below is the full kit which includes PCB, all necessary graphics, buttons, joysticks and a volume/test bracket. This kit is used for a cabinet that will be upgraded with the CPS II board for the first time. The second kit is called the "B" Kit. This kit is for any that already uses the CPS II board (Super Street Fighter II). This kit includes the "B" board, all necessary graphics and volume/test bracket. You just remove the top cartridge off the motherboard and replace with the new cartridge.

## EF1000

### Eco Fighter Kit

Part No.	Description	Qty.
EF1400	Eco Fighter PCB	1
GE3080	Blue Marble Overlay	1
06-0061	Eco Fighter Marquee	1
GE1200	Monitor Card	1
16-0130	1 Player Button	1
16-0131	2 Player Button	1
16-0133	Red Button	2
16-0136	Green Button	2
16-0134	Blue Button	2
GE2030	Joystick	2
06-0045	Side Graphics	2
03-0050	Volume/Test Bracket	1
19-0015	Eco Fighter Manual	1
06-0068	Instruction Decal	1

## EF1000B

### Eco Fighter B Kit

Part No.	Description	Qty.
EF1400B	Eco Fighter "B" Board	1
GE3080	Blue Marble Overlay	1
06-0061	Eco Fighter Marquee	1
06-0068	Instruction Decal	1
19-0015	Eco Fighter Manual	1

---

# CONTROL LOCATIONS

## 1. SAMPLE CONTROL PANEL LAYOUT

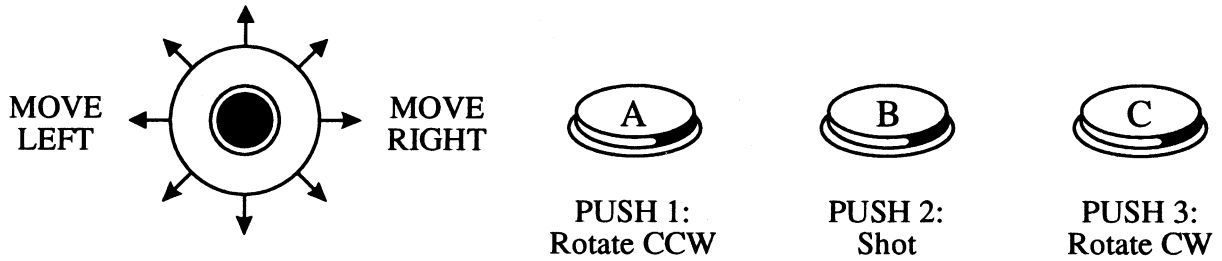

## 2. VOLUME AND TEST CONTROL SWITCHES ON BOARD

The volume of this unit can be adjusted by pressing the volume-up switch and the volume-down switch. **The setting you have selected will be stored even if the power is turned off.** In the event that the volume setting does not work properly, press down on either the volum-up or the volume down switch **for at least five seconds, then set the volume again.**

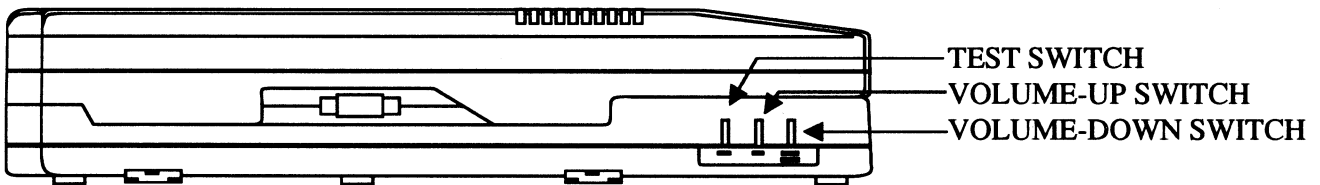

## 3. VOLUME AND TEST CONTROL BRACKET

To be mounted on top of the coin box.

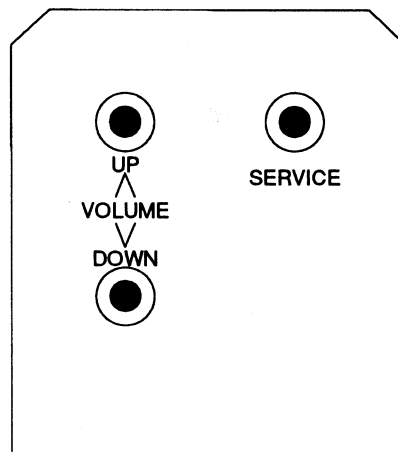

# CONNECTORS

- **JAMMA:** JAMMA 56-pin connector
- **OPTION:** Player 3 and Player 4 Interface
- **AUDIO OUT:** Used only for CAPCOM QSOUND cabinet
- **REGISTER:** Optional I/O connector for register

## JAMMA CONNECTOR

SOLDER SIDE			COMPONENT SIDE
GND	A	1	GND
GND	B	2	GND
+5V	C	3	+5V
+5V	D	4	+5V
N.C.	E	5	N.C.
+12V	F	6	+12V
	H	7	
N.C.	J	8	COUNTER 1
LOCK OUT 2	K	9	LOCK OUT 1
SPEAKER (-)	L	10	SPEAKER (+)
N.C.	M	11	N.C.
VIDEO GREEN	N	12	VIDEO RED
VIDEO SYNC	P	13	VIDEO BLUE
FREE CREDIT	R	14	VIDEO GND
N.C.	S	15	DIAGNOSIS
2P COIN	T	16	1P COIN
2P START	U	17	1P START
2P UP	V	18	1P UP
2P DOWN	W	19	1P DOWN
2P LEFT	X	20	1P LEFT
2P RIGHT	Y	21	1P RIGHT
2P PUSH 1	Z	22	1P PUSH 1
2P PUSH 2	a	23	1P PUSH 2
2P PUSH 3	b	24	1P PUSH 3
N.C.	c	25	N.C.
N.C.	d	26	N.C.
GND	e	27	GND
GND	f	28	GND

## OPTION CONNECTOR

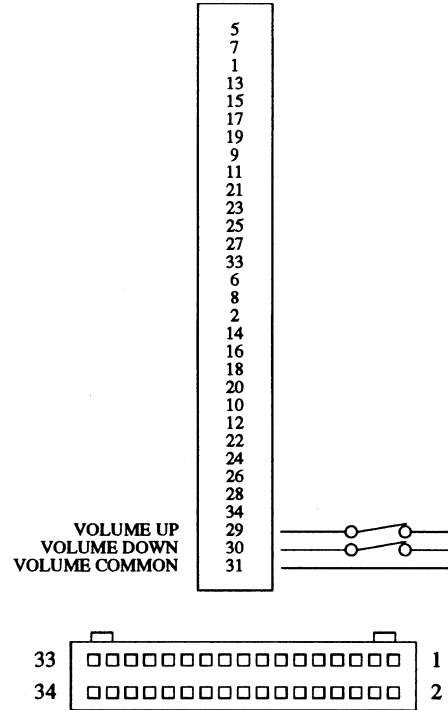

Harness Side

## CONNECTOR LOCATIONS

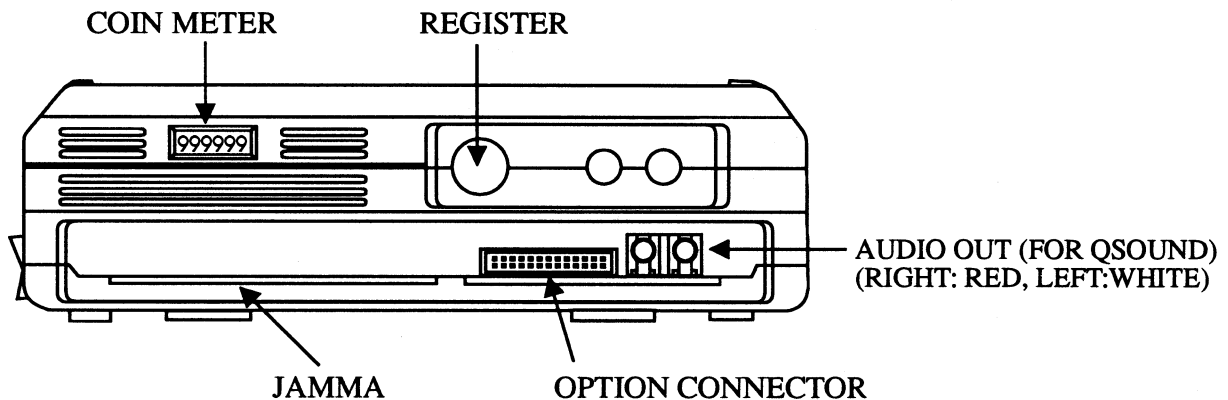

---

# TEST MENU

The test menu allows you to test the functions and controls of the game. These items include input devices such as joysticks, buttons and coin mechs, output devices such as monitor, speakers and meters. Through the Test Menu you can also access the Configuration Menu, where you can change the settings of the game.

## 1. ACCESSING THE TEST MENU

- **For a CAPCOM cabinet, or a cabinet equipped with a test switch:**  
Turn on the main switch, then push the test switch. The screen shown below will appear.
- **For a cabinet without a test switch:**  
Push the test switch on the side of the blue plastic electronic casing. Refer to the Controls Section of the manual.

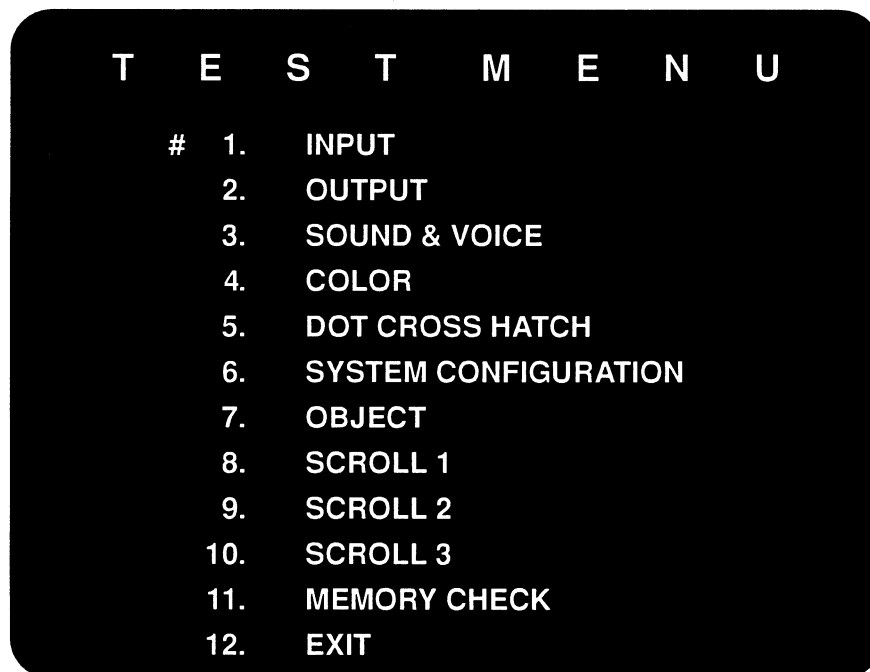

## 2. HOW TO SELECT AN ITEM

- Use the Player 1 Joystick to Move the pound sign (#) in front of the desired item and press the Player 1 A (Rotate CCW) button.
- To return to the test menu, push the Player 1 Start and Player 2 Start Buttons simultaneously. The test menu automatically appears:
  - After you exit the "**6. SYSTEM CONFIGURATION MENU**".
  - After the memory is tested on the menu of "**11. MEMORY CHECK**".

## 3. CLOSING THE TEST MENU

To close the Test Menu, move the pound sign (#) in front of "11. EXIT" and push the Player 1 Attack Button.



#### 4. TEST MENU ITEM DESCRIPTIONS

INPUT		Used to test all the input switches. "1" appears when the switches are depressed.
OUTPUT		Check connections and switches in case "0" appears when switches are depressed.
SOUND & VOICE		Select a code of SOUND or VOICE with the Player 1 Joystick. Push the Player 1 A (Rotate CCW) button to hear the sound of the selected code, then adjust the volume.
COLOR		Shows color bars of red, green, blue and white. Adjust RGB and brightness to obtain the optimum color balance and solid black background.
DOT CROSS HATCH		Used to test the screen size, focus and distortion.
SYSTEM CONFIGURATION		Used to change the game play settings. Refer to the SYSTEM CONFIGURATION MENU section.
7, 8, 9, 10		Used to check all the characters of the game.
MEMORY TEST		Used to test memory. "OK" appears when each block of memory passes test "ERROR" appears in case of malfunction. If "ERROR" appear, repeat the memory test. Contact your distributor if "ERROR" still appears.
EXIT		Select this item and push the Player 1 A (Rotate CCW) button to return to game play mode.

---

# SYSTEM CONFIGURATION MENU

## 1. TO OPEN THE MENU

- From the Test Menu, highlight "**6. SYSTEM CONFIGURATION**" and push the Player 1 A (Rotate CCW) button. The screen below will be displayed.



## 2. CHANGING THE CONFIGURATION SETTINGS

- Move the Player 1 Joystick UP or DOWN to highlight the desired option. Once the option is highlighted, move the Joystick LEFT or RIGHT to change the setting. Refer to menu on the next page for option settings.

## 3. SAVING SETTINGS AND CLOSING THE MENU

- Once the configuration settings are changed, save the new settings by highlighting "**EXIT**" and pushing the Player 1 A (Rotate CCW) button.
- A message "**SAVING NEW CONFIGURATION IN EEPROM**" appears while new settings are being saved. It takes one or two seconds to save the new settings. Do not turn off the power switch while saving is in process.

#### 4. SYSTEM CONFIGURATION MENU OPTIONS

COIN	<b>1 COIN 1 CREDIT</b>	1 COIN 2 CREDITS	1 COIN 3 CREDITS	1 COIN 4 CREDITS	1 COIN 6 CREDITS
	2 COINS 1 CREDIT	3 COINS 1 CREDIT	4 COINS 1 CREDIT	2 COINS START 1 COIN CONTINUE	
CONTINUE	<b>ON</b>			OFF	
GAME DIFFICULTY	LEVEL 1 EASIEST	LEVEL 2 VERY EASY	LEVEL 3 EASY	LEVEL 4 MEDIUM	
	<b>LEVEL 5 MEDIUM HARD</b>	LEVEL 6 HARD	LEVEL 7 VERY HARD	LEVEL 8 HARDEST	
EXTEND	<b>1ST 400000 PTS 2ND 800000PTS</b>	1ST 600000 PTS 2ND 1000000PTS	ONLY 600000 PTS	NOTHING	
PLAYERS	2	<b>3</b>	4	5	
SOUND	<b>STEREO (Q SOUND)</b>			MONAURAL	
FLIP	ON			<b>OFF</b>	
DEMO SOUND	ON			<b>OFF</b>	

- Factory settings are in bold face.
- After you change the setting, make sure to select "EXIT" and push the Player 1 Start button.
- Choose **STEREO (QSOUND)** if your cabinet is equipped with the Qsound Speaker System, otherwise select **MONAURAL** for proper sound effect.

## 5. SYSTEM CONFIGURATION ITEM DESCRIPTIONS

COIN	Sets the charge per play
CONTINUE	<p>Allows a player to continue playing after he loses. Extra money will need to be added to continue.</p> <p><b>ON:</b> Continuous play is possible</p> <p><b>OFF:</b> Continuous play is not possible</p>
GAME DIFFICULTY	The higher the number, the more difficult the game play.
EXTEND	<p>Points required for extra life.</p> <ul style="list-style-type: none"> <li>• 1ST 400000 PTS, 2ND 800000 PTS</li> <li>• 1ST 600000 PTS, 2ND 1000000 PTS</li> <li>• ONLY 600000 PTS</li> <li>• NOTHING</li> </ul>
PLAYERS	Number of lives.
SOUND	<p>STEREO or MONAURAL.</p> <p><b>STEREO:</b> with QSOUND    <b>MONAURAL:</b> without QSOUND</p> <p>QSOUND is available with CAPCOM QSOUND cabinets only.</p> <p>For other cabinet, please set to MONAURAL</p>
FLIP	<p>Flips the screen. If the screen appears upside down, change the setting.</p> <p><b>ON:</b> Upside down      <b>OFF:</b> Right side up</p>
DEMO SOUND	Turns attract sound on or off.
FACTORY SETTING	To return to the factory default settings, select this item and push the PLAYER 1 START button.
EXIT	To save the setting changes and return to the TEST MENU, highlight this item and push the PLAYER 1 START button.

---

# MOUNTING THE PC BOARD

## 1. INSTALLING THE MOUNTING BRACES

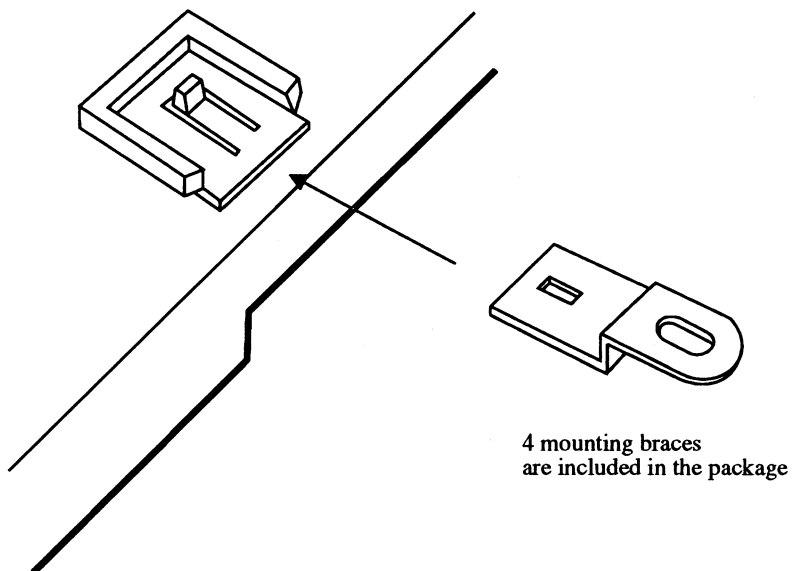

## 2. MOUNTING THE PCB

These screws are not included  
in the package.

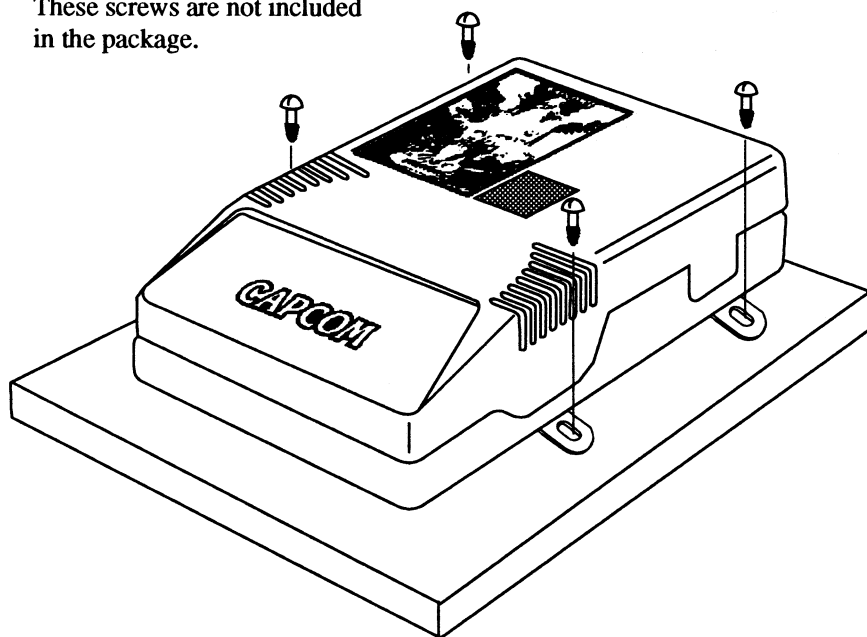

# HOW TO REMOVE THE TOP "B" CARTRIDGE

In the future, there will be the capability to remove the top "B" cartridge so that a game can be converted to a new game or upgraded to a different version. It is very important only to separate the top cartridge from the main board only. **Dissassembling either case will void your warranty.** Follow the instructions below to separate the two assemblies.

- Remove the 2 case clamps.
- Carefully pull the the "B" cartridge off the bottom cartridge.

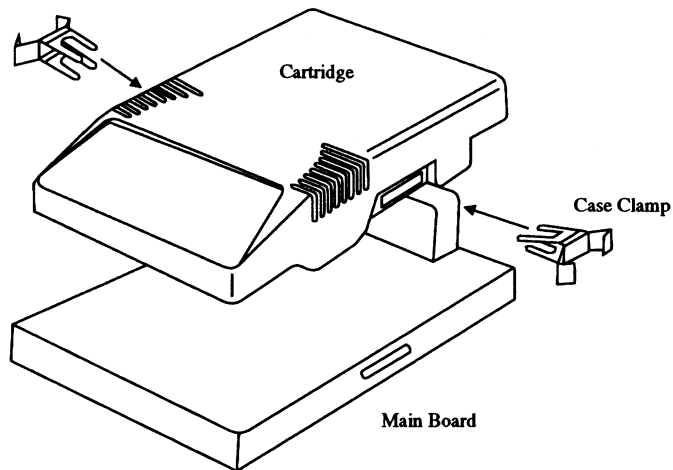

## STICKER DESCRIPTIONS

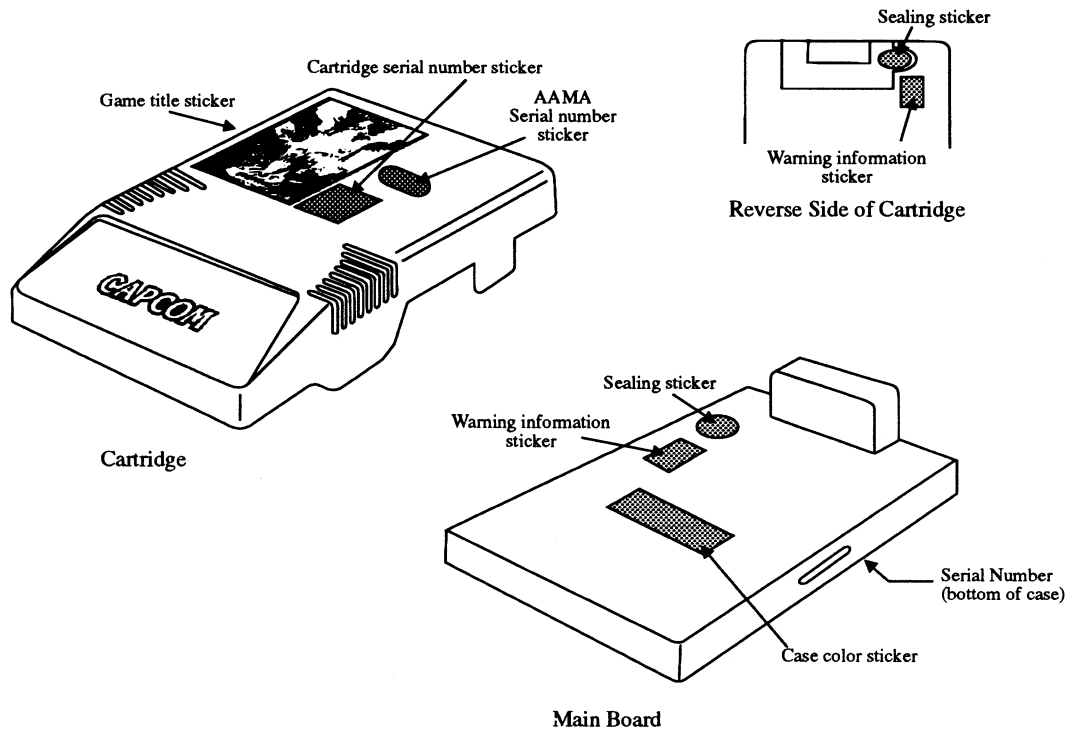

**Disassembling the case or removing the sealing stickers will void your warranty!**



**CAPCOM®**

535 Oakmead Parkway  
Sunnyvale, CA 94086