

namco®



SOUL CALIBUR II

Game PCB Kit

Connections
and
Adjustments

NOTICE

MAGICGATE is a term to describe a copyright protection technology created by Sony Group. This **MAGICGATE** mark does not necessarily guarantee compatibility with other products bearing the “MagicGate” trademark.

MAGICGATE is a trademark of Sony Corporation.

MAGICGATE est un terme décrivant une technique de protection de copyright créée par Sony Group. **MAGICGATE** ne garantit pas nécessairement de compatibilité avec d'autres produits portant la marque de commerce “MagicGate”

MAGICGATE est une marque de commerce de Sony Corporation.

The DVD-ROM DISC supplied with the product must not be copied, modified, distributed, or used for purposes other than the operation of the product. Copyright laws protect the contents of the DVD-ROM DISC. Infringement of copyright laws may be subject to criminal penalties.

Do not use the supplied DVD-ROM DISC with other product models or other media formats. Doing so may result in equipment failure.

Contents

KIT CONTENTS	5
1. SPECIFICATIONS	7
2. CABINET CONNECTIONS (Standard Jamma).....	7
3. CABINET CONNECTIONS (JVS Standard).....	11
4. FITTING THE DONGLE & MEMORY CARD	12
5. FITTING THE CD-ROM DISC	13
6. ADJUSTMENTS AND SETTINGS	15
6-1 Option Switches	15
6-2 Test Mode	16
6-2-1 Display Test.....	16
6-2-2 Colour Edit	18
6-2-3 Convergence.....	18
6-2-4 Interlace	19
6-2-5 Input Test (switch test)	20
6-2-6 Game Options.....	21
6-2-7 Coin Options	22
6-2-8 Sound Test	23
6-2-9 JVS Status	23
6-2-10 A. D. S - (Bookkeeping)	24
6-2-11 Data Clear	24

KIT CONTENTS

Description	Part No	Quantity
Soul Calibur 2 PCB Rack Assy	XSC2-PCB	1
DVD Rom CD Disc	XSC2-CDROM	1
Jamma (B) PCB	XTEK4-JAMMA	1
Rack Assy to Jamma (B) PCB connecting cables	Power Supply Loom	1
	RGB Video Loom	1
	RCA (Phono) Audio Loom	1
	Data Loom	1
Amp EI connectors to 48way Edge Adaptor Loom	69200067	1
Amp EI connectors with Flying Leads Loom	69200066	1
Button Decals		1 set
Instruction Card		1
Move List Card		1
Title Board		1
Soul Calibur 2 Promotional Poster		1
Top Flash	40000736	1
Universal Cabinet Side Decal - LHS / RHS	40000735	2
Header Decal	40000734	1
Connection and Adjustment Manual	90500138	1

1. SPECIFICATIONS

COMPATIBILITY: JAMMA STANDARD (with JAMMA (B) PCB)
JAMMA VIDEO STANDARD (JVS)

PCB INPUT POWER: +5v ($\pm 5\%$) @ 7A (Min), +12v ($\pm 5\%$) @ 2A (Min)

OPERATING ENVIRONMENT: Temperature +5°C to +45°C
Humidity 10% to 85% (no condensation)

MONITOR ORIENTATION AND SIGNAL:

Orientation	Horizontal (Landscape)
Horizontal Frequency	15kHz / 31kHz (selectable)
Scanning retrace	15.75 kHz Non-interlace / Interlace 31.5 kHz Non-interlace (fixed)
RGB output level	At 15 kHz 0.7V p-p / 3.0V p-p (selectable) At 31 kHz 0.7V p-p
Composite Sync / Separate Sync (selectable)	
Vertical sync frequency:	60.0 Hz

2. CABINET CONNECTIONS (Standard Jamma)

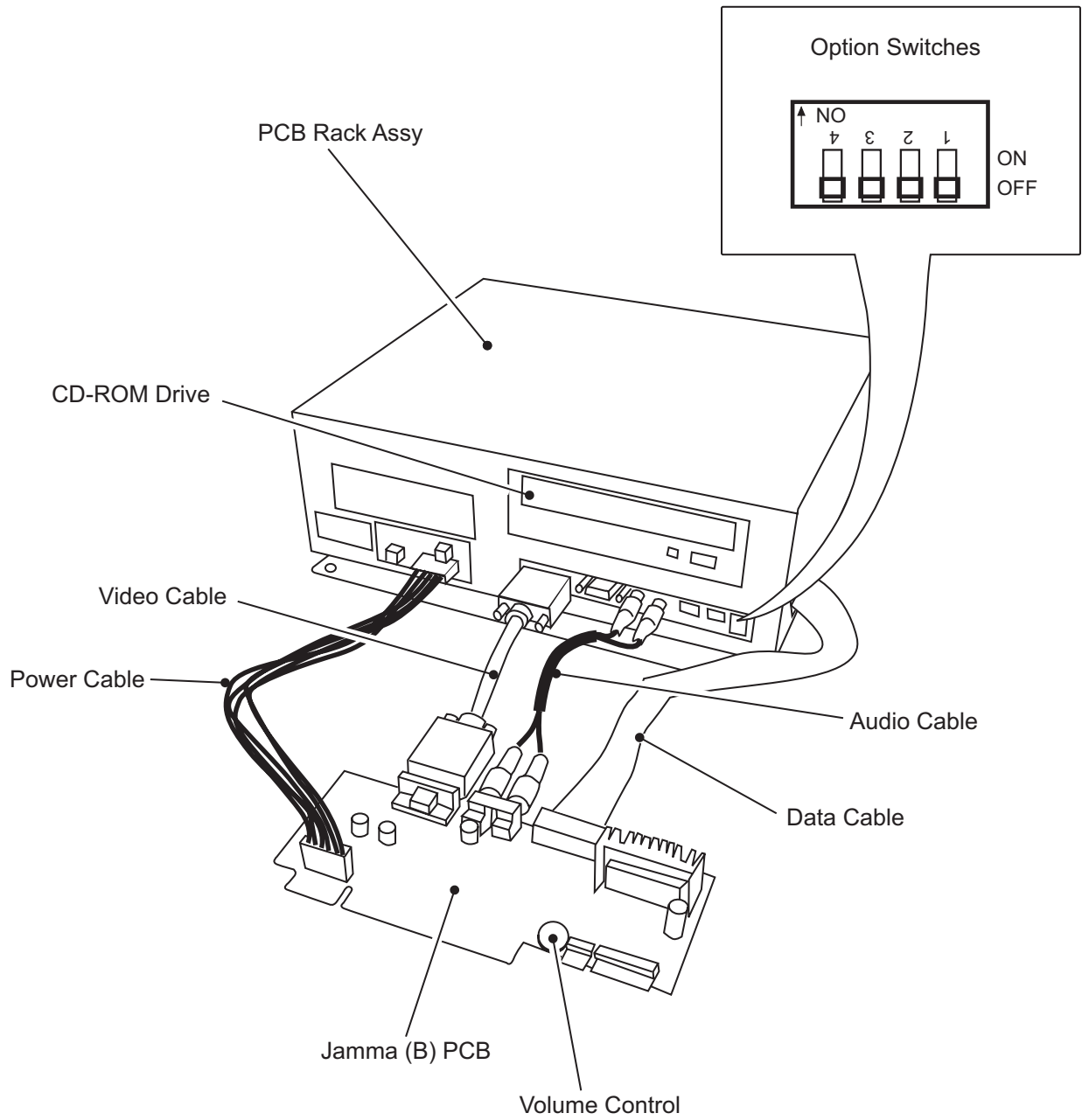

The JAMMA (B) PCB is connected to the game cabinet with a 56way Edge Connector (standard JAMMA) and 4 and 10way AMP EI Connectors.

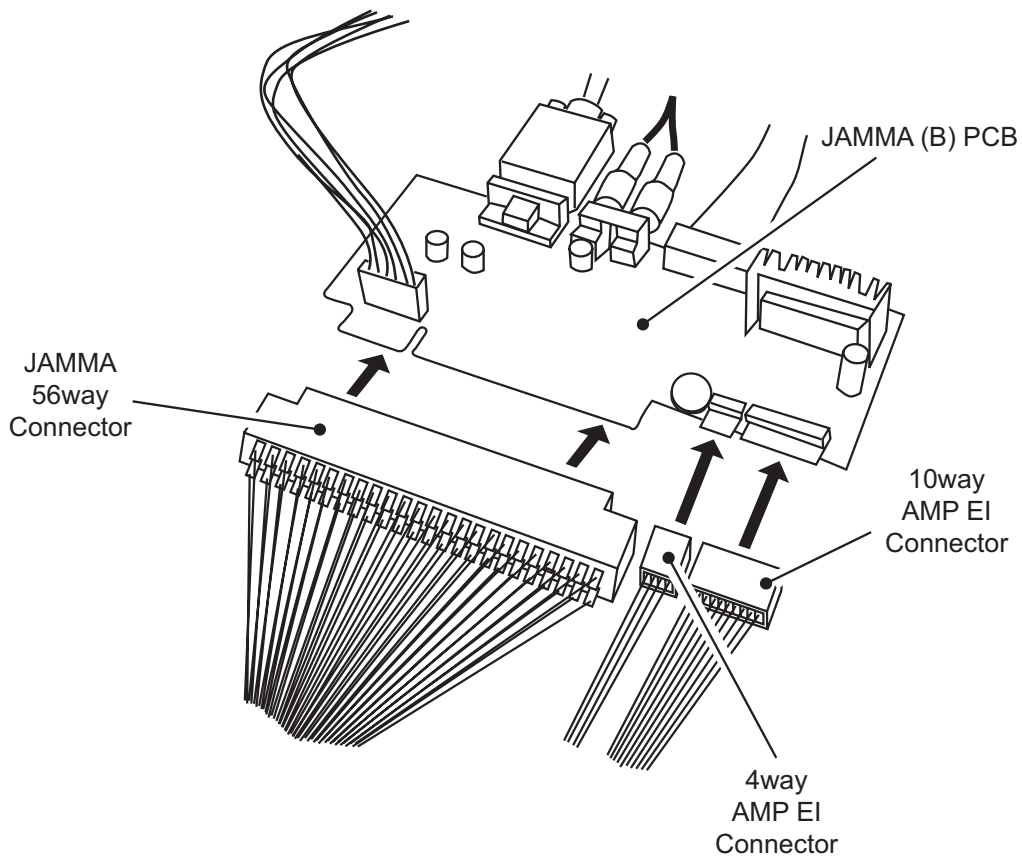

Note: Supplied in the Kit is an Amp EI connector to 48way extender card adaptor loom for cabinets with an existing 48way connector, and an AMP EI connector with flying leads loom for cabinets without a 48way connection.



4 and 10way AMP EI Connector with 48way Extender Card
Part No. 69200067



4 and 10way AMP EI Connector with flying leads
Part No.69200066

Connections for Standard JAMMA Cabinet

SOUL CALIBUR 2			
JAMMA 56way Edge Connector			
Solder Side	Terminal No		Component Side
GND	A	1	GND
GND	B	2	GND
+5volt	C	3	+5volt
+5volt	D	4	+5volt
	E	5	
+12volt	F	6	+12volt
Polarizing Key	G	7	Polarizing Key
Coin Counter 2	H	8	Coin Counter 1
	J	9	
L Speaker (-)	K	10	L Speaker (+)
Audio (-) (mono)	L	11	Audio (+) (mono)
Video GREEN	M	12	Video RED
Video SYNC	N	13	Video BLUE
SERVICE	P	14	Video GND
	R	15	TEST
Coin Switch 2	S	16	Coin Switch 1
P2 START	T	17	P1 START
P2 Joystick UP	U	18	P1 Joystick UP
P2 Joystick DOWN	V	19	P1 Joystick DOWN
P2 Joystick LEFT	W	20	P1 Joystick LEFT
P2 Joystick RIGHT	Y	21	P1 Joystick RIGHT
P2 Button switch Sw1	Z	22	P1 Button switch Sw1
P2 Button switch Sw2	a	23	P1 Button switch Sw2
P2 Button switch Sw3	b	24	P1 Button switch Sw3
	c	25	
	d	26	
GND	e	27	GND
GND	f	28	GND

SOUL CALIBUR 2	
10way AMP EI Connector	
Pin No	Description
1	GND
2	
3	
4	P2 Button switch 4
5	
6	
7	
8	P1 Button switch 4
9	
10	GND

SOUL CALIBUR 2	
4way AMP EI Connector	
Pin No	Description
1	
2	
3	R Speaker (+)
4	R Speaker (-)

**Connector Loom
(Part no 69200067)**
(with 48way connector
and adaptor PCB)

**Connector Loom
(Part no 69200066)**
(with flying leads)

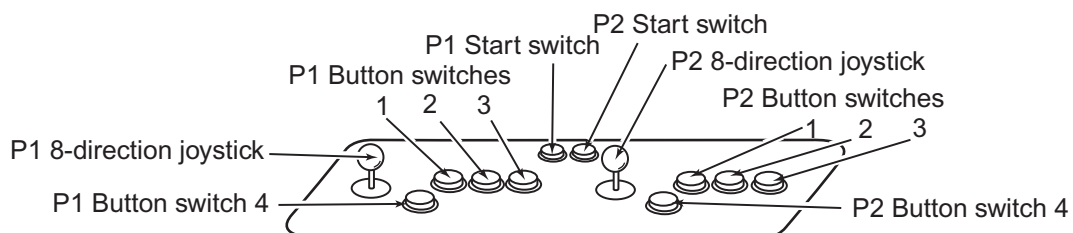

**Adaptor for Earlier Tekken Series Cabinets
with 48way Edge Connector
(Part No 69200067)**

PREVIOUS CABINETS					
48way Extension Connector					
Solder Side		Terminal N		Component Side	
4w AMP EI pin 4)R Speaker (-	A24	B24	R Speaker (+)	4w AMP EI pin
		A23	B23		
		A22	B22		
		A21	B21		
	Polarizing Key	A20	B20	Polarizing Key	
		A19	B19		
		A18	B18		
10w AMP EI pin 4	P2 Button switch	A17	B17		10w AMP EI pin 1 10w AMP EI pin 1
		A16	B16		
		A15	B15	GND	
		A14	B14	GND	
		A13	B13		
		A12	B12		
		A11	B11		
		A10	B10		
		A9	B9		
		A8	B8	GND	10w AMP EI pin
		A7	B7	GND	10w AMP EI pin
		A6	B6		
10w AMP EI pin 8	P4 Button switch	A5	B5		
		A4	B4		
		A3	B3		
		A2	B2		
		A1	B1		

3. CABINET CONNECTIONS (JVS Standard)

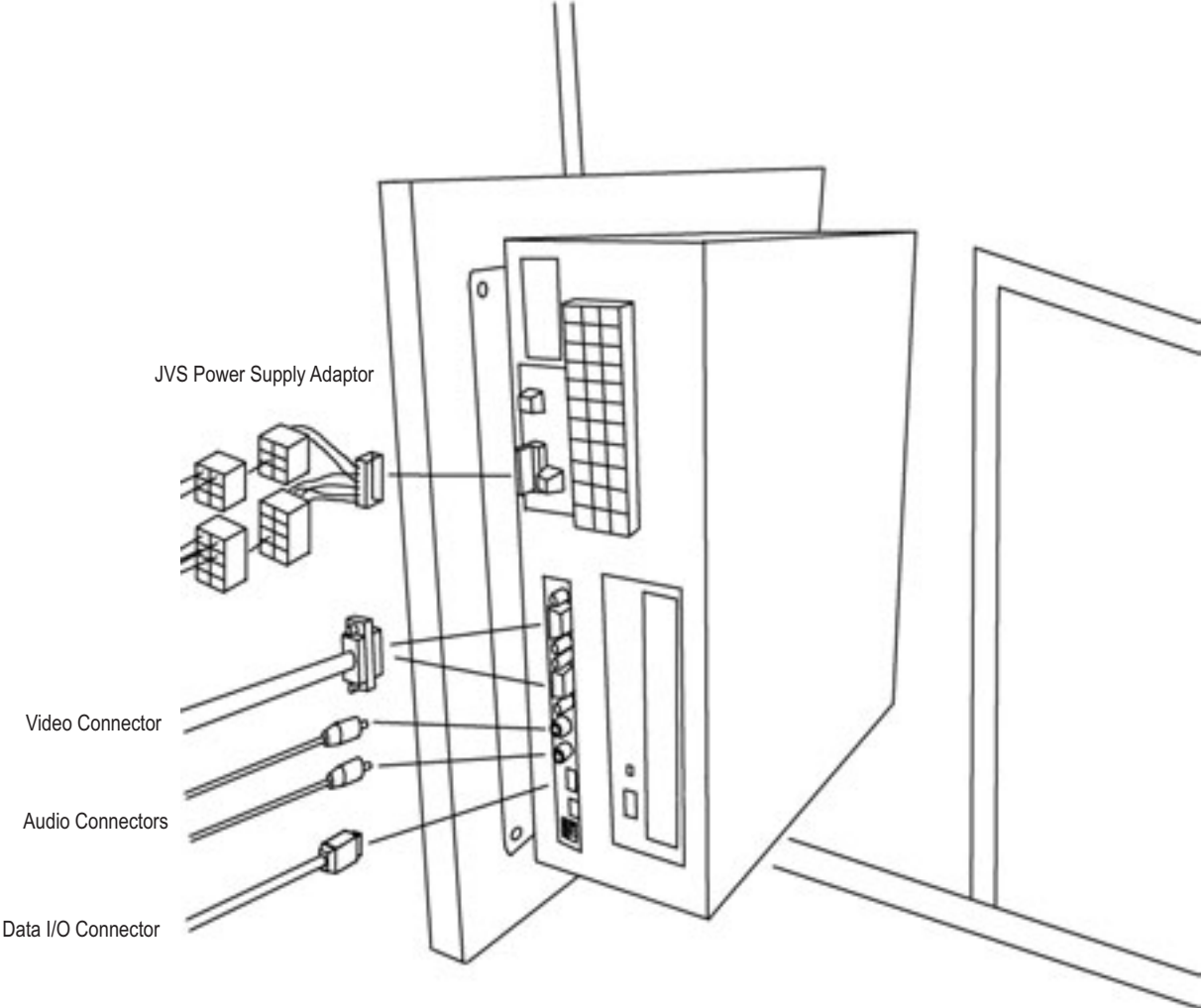

4. FITTING THE DONGLE & MEMORY CARD

The dongle and memory card included in this kit is limited to this game only. DO NOT insert this Dongle in other games. Inserting the Dongle in other games may cause damage.

Ensure that the power is switched OFF before inserting the Dongle.

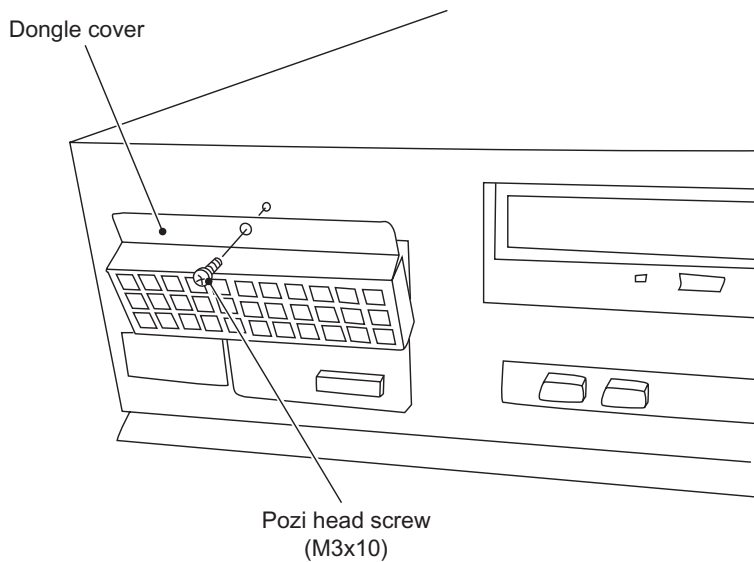

1. Remove 1 off pozi head screw (M3x10) and remove the Dongle Cover.
2. Fit the Dongle to the left hand connector.
3. Fit the Memory Card to the right hand connector.

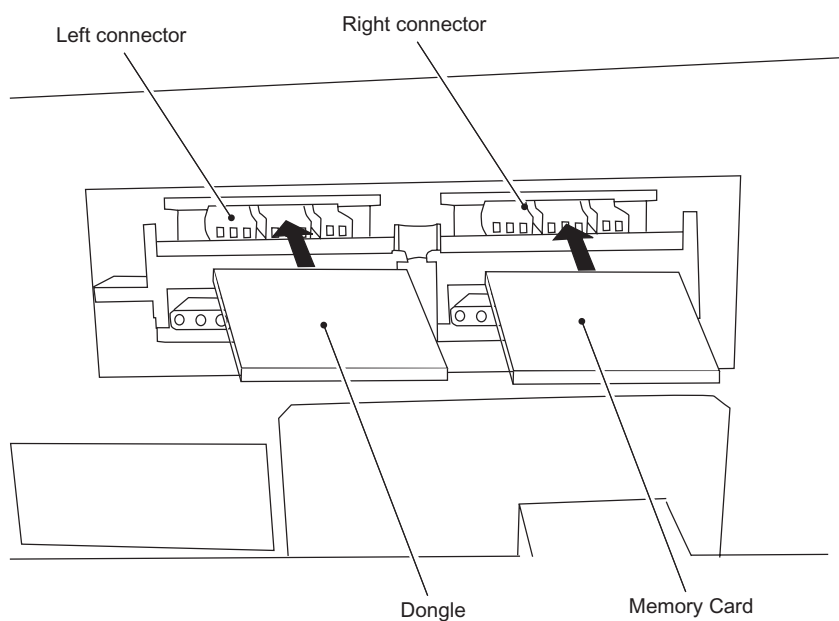

4. Refit the Dongle cover and pozi head screw (M3x10)

5. FITTING THE CD-ROM DISC

- The CD-ROM Disc must be inserted with the power switched on. To prevent an electric shock, accident or injury, do not touch any parts other than those specified below.
- The supplied CD-ROM Disc is designed exclusively for this product. Never use the CD-ROM Disc in any other product. Do not insert other CD-ROM Discs in the CD-ROM drive of this game.
- The CD-ROM tray retracts automatically after 10 seconds.

1. Press the eject button of the CD-ROM drive to open the tray.

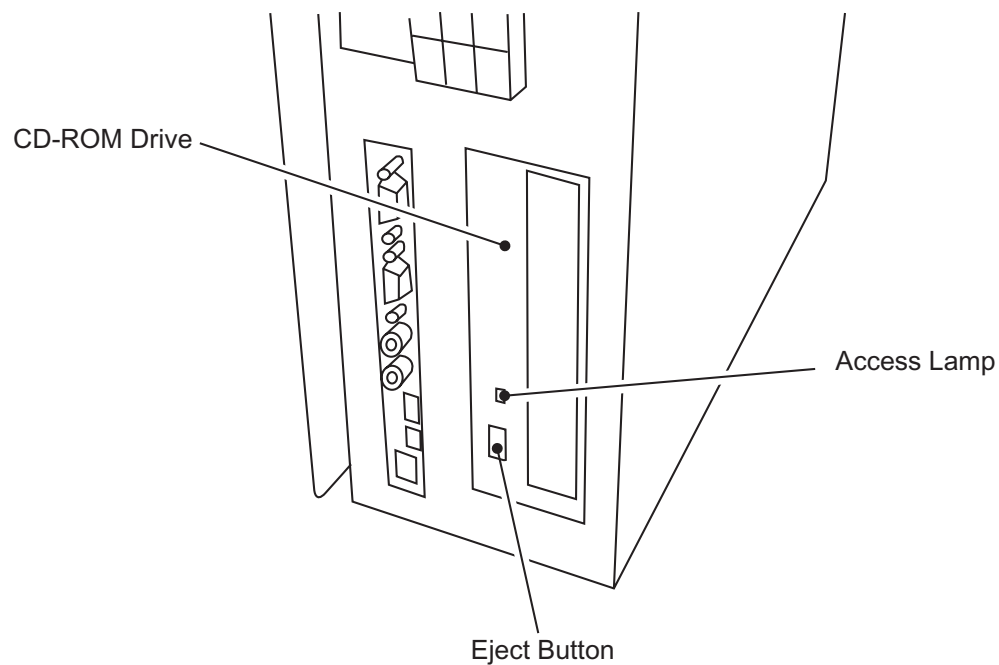

2. Place the CD-ROM Disc on to the tray, ensuring that the label side (printed surface) is facing away from the Tray.

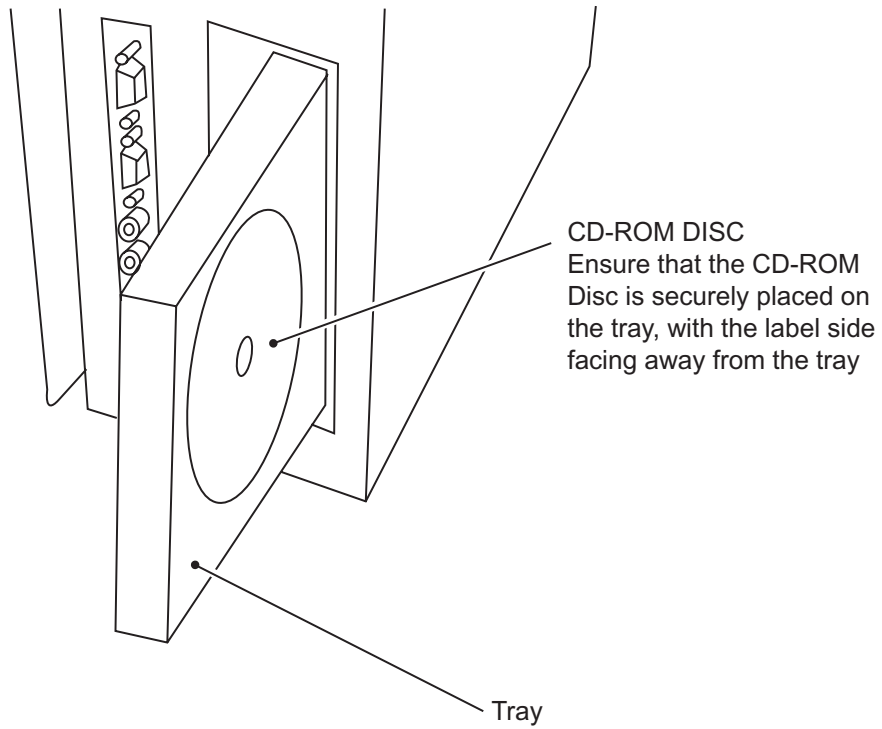

3. Press the Eject button to retract the Tray in to the unit.
4. Switch the power OFF, wait approx 10 seconds then switch the game back ON.

6. ADJUSTMENTS AND SETTINGS

The Game PC Board Assy is fitted with 4 Option Switches.

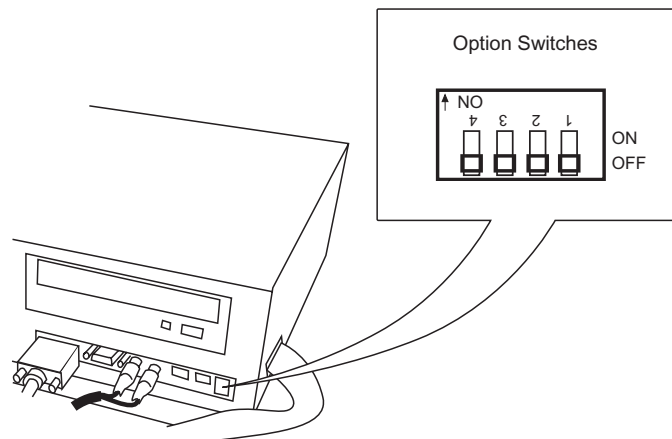

The JAMMA (B) PCB has the Volume Control fitted.

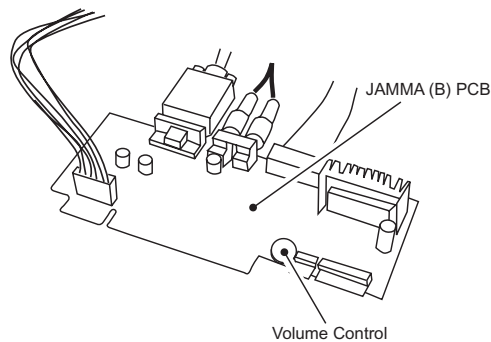

6-1 Option Switches

Switch 1 is used to change between Test Mode and Game Mode.

ON: Test Mode OFF: Game Mode

Switch 2 is used to set the output level of the video signal.

31kHz	ON: 0.7V p-p	OFF: 0.7V p-p
15kHz	ON: 0.7V p-p	OFF: 3.0v P-P

Switch 3 is used to change the monitor Sync Frequency

ON: 31kHz OFF: 15kHz

Note: When using a 31kHz monitor, set the RGB input of the monitor to 0.7v. If the monitor does not have a setting adjustment, refer to page 17 section 6-2-1 "Display Test", and change the Contrast and RGB Brightness levels to adjust the brightness.

Switch 4 is used to set the Video Sync Signal

ON: Composite Sync OFF: Seperate Sync

Note: The game must be switched OFF and back ON for changes to switches 2,3, and 4 to take effect.

6-2 Test Mode

To enter Test Mode set the Test switch in the cabinet (if fitted) to ON, or if no Test switch is fitted to the cabinet, set Option switch 1 ON

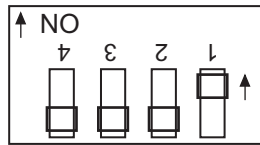

Note: The test mode is activated only when the cabinet Test switch or Option switch 1 is moved from OFF to ON. If the game is switched on with either switch in the ON position the Test Mode will not be activated. The switch must be switched OFF and then ON to enter the test mode.

When the Test Mode is entered, the following screen is displayed.

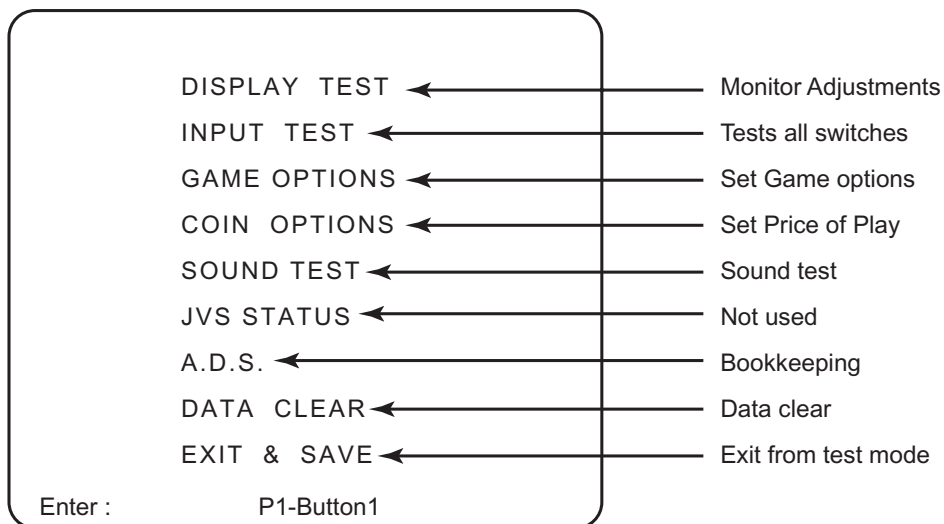

Use the Joystick Up or Down to step through the tests. (The selected test will be displayed in red)

Press the 1 Player Button 1 to enter the selected test.

After making adjustments select EXIT and press the 1 Player Button 1 to return to the above screen. Select another test or select 'EXIT & SAVE' and press the 1 Player Button 1 to save the changes and return to the Game Mode.

Note: If 'EXIT &SAVE' is not selected and activated, any changes made may not be stored properly. Switching the cabinet Test switch or Option 1 switch OFF does not exit the Test Mode.

Switch the cabinet Test switch or Option 1 switch OFF.

6-2-1 Display Test

This test allows the following checks and adjustments to be made.

- **Colour Edit**
Adjust contrast and brightness of each colour to match video output from the PCB to the Monitor.
Note: This adjustment should only be made if the correct picture quality cannot be achieved by using the normal monitor adjustments.
- **Convergence**
Check and adjust the size, position and distortion of the screen image.
- **Interlace Check**
Switches between interlaced and non-interlaced display. (Only with 15kHz video signal).

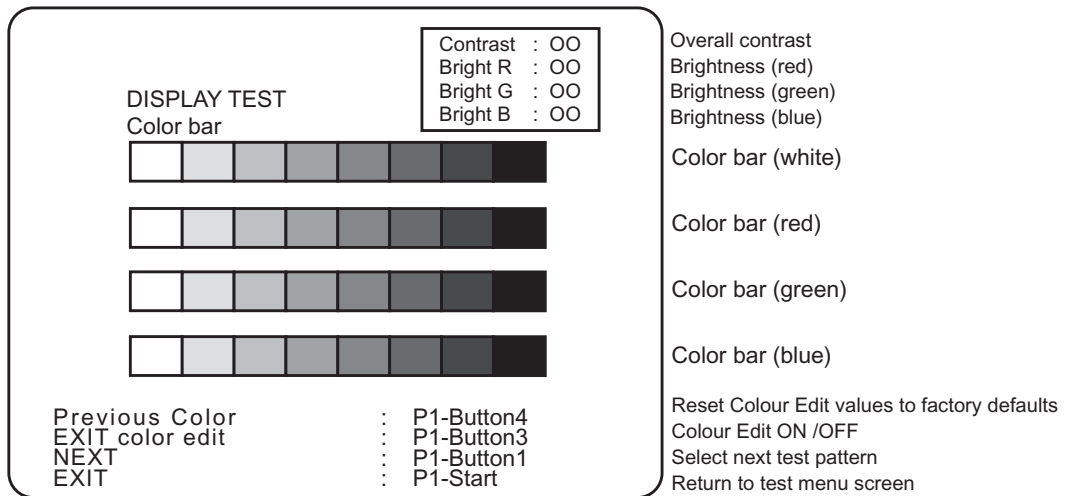

1. Select display Test from the Test Menu Screen, the following screen is displayed.
2. Each time the 1P Button 3 is pressed the Colour Edit adjustment box is turned ON or OFF.

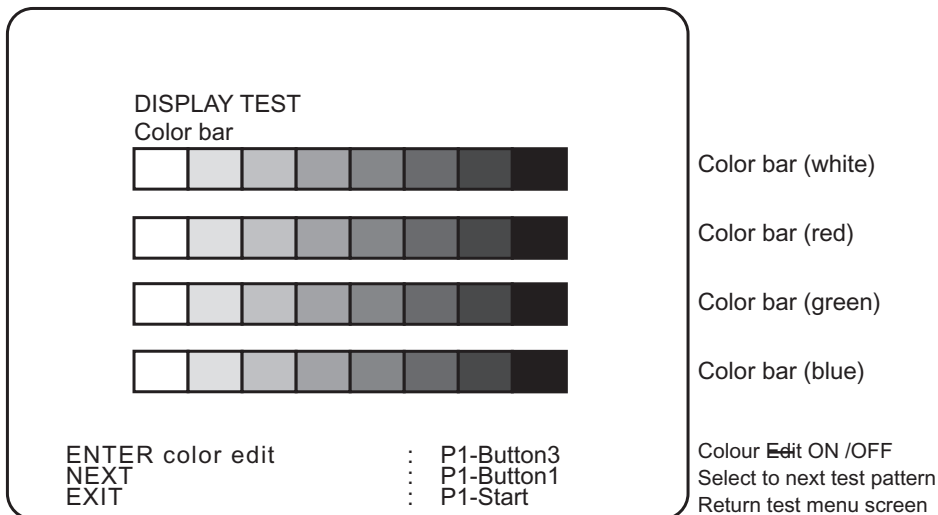

3. Press the 1P Button 1 to step to the next test function

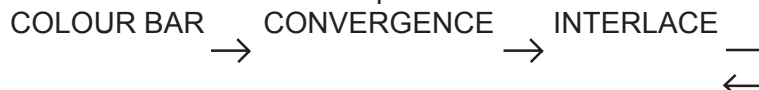

6-2-2 Colour Edit

1. Ensure that the Colour Edit Adjustment Box is showing. (Press P1 Button 3 if the Adjustment box is not displayed).
2. Use the Joystick UP/DOWN to step to the required adjustment. (Contrast, Brightness (red), Brightness (green), Brightness (blue)).
3. Use the Joystick LEFT/RIGHT to adjust the value.
3. When all adjustments have been made, press P1 Button 1 to step to the Convergence Test or P1 Start Button to return to the Main Test Menu screen

6-2-3 Convergence

Use this screen to adjust the geometry (height, width , etc.) of the Monitor.

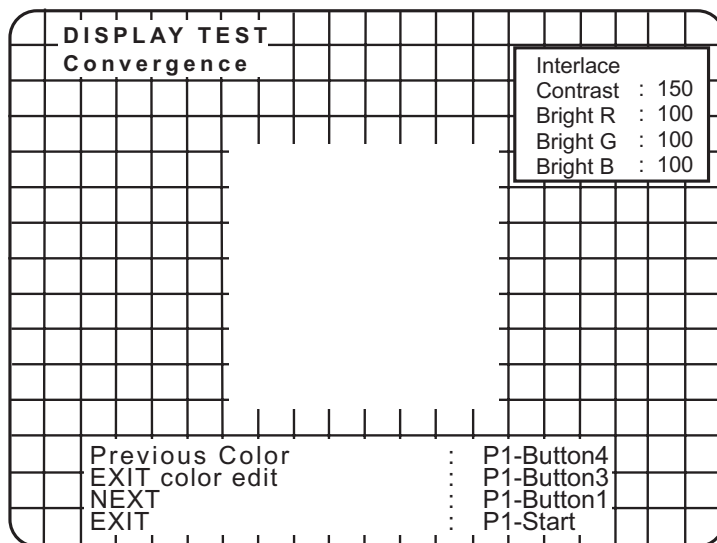

When all adjustments have been made, press P1 Button 1 to step to the Interlace Test or P1 Start Button to return to the Main Test Menu screen.

6-2-4 Interlace

Interlace Mode: This mode provides more detailed and smoother graphics than the non-interlaced mode. This is achieved by shifting the picture display a half line in the vertical direction every other frame scan, so doubling the vertical resolution without changing the horizontal/vertical frequency.

Non-Interlaced Mode: Use this display if the interlace mode results in flicker over the entire screen display. In the non-interlaced mode, there is no shift of the display position, and the display remains constant every time.

1. Ensure that the Colour Edit Adjustment Box is showing. (Press P1 Button 3 if the Adjustment box is not displayed.)
2. Use the Joystick LEFT/RIGHT to change Interlace/Non Interlace.

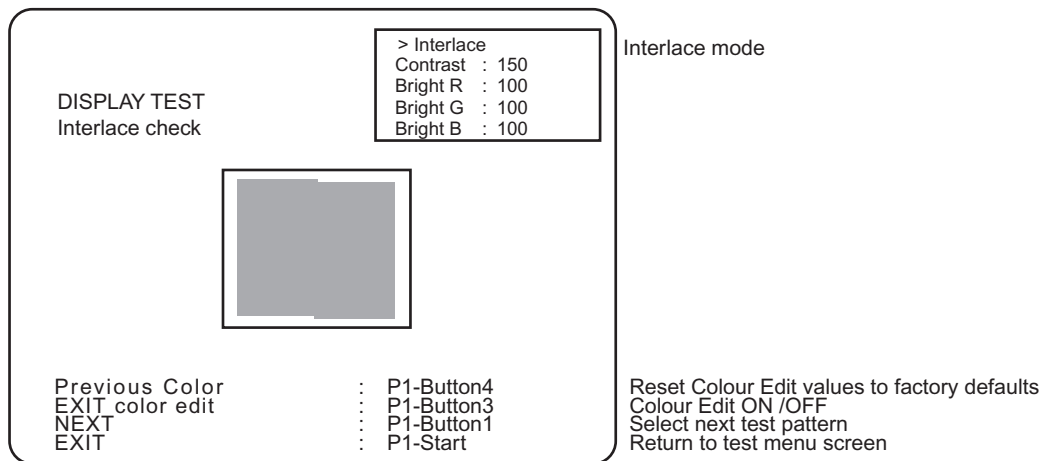

Interlace mode is set ON

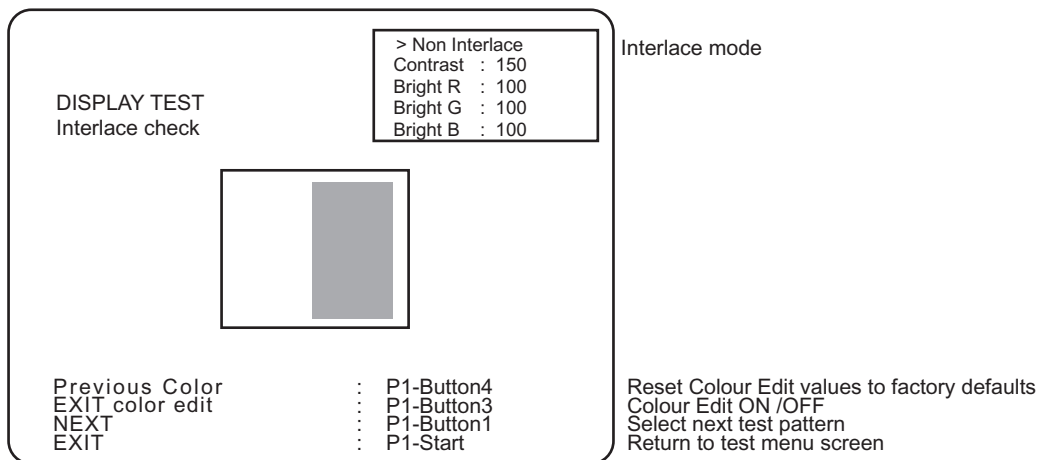

Interlace mode is set OFF

3. When the adjustment has been made, press P1 Button 1 to step back to the Colour Edit Test or P1 Start Button to return to the Main Test Menu screen.

6-2-5 Input Test (switch test)

Select Input Test from the Main Test Menu. The following screen is displayed.

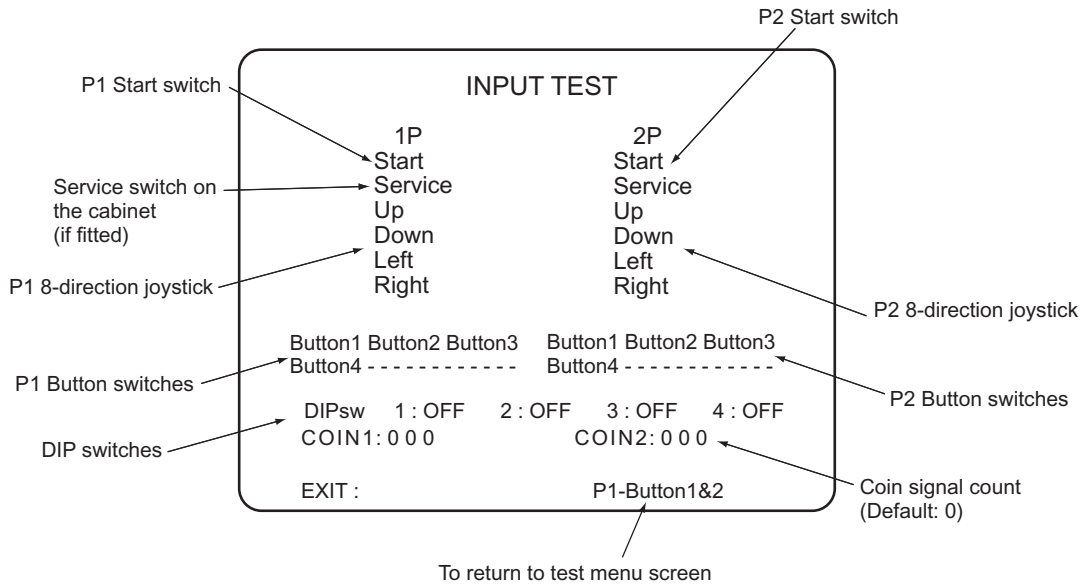

Each time a switch is operated, the corresponding item on the display will change colour to red.

When testing is completed, press P1 Buttons 1 and 2 together to return to the Main Test Menu screen.

6-2-6 Game Options

1. Select Game Options from the Main Test Menu. The following screen is displayed.

GAME OPTIONS
< Defaults in Green >

(a) >DIFFICULTY LEVEL : Normal
 (b) FIGHT COUNT<ARCADE> : 2
 (c) FIGHT COUNT<VS GAME> : 2
 (d) LIFE BAR<ARCADE> : 100
 (e) LIFE BAR<VS GAME> : 100
 (f) ROUND TIME<ARCADE> : 50sec
 (g) ROUND TIME<TRAINING> : 5min
 (h) NEUTRAL GUARD : On
 (i) CHARACTER CHANGE AT CONTINUE : Off
 (j) CHARACTER CHANGE AT VS GAME : Off
 (k) SOUND IN ATTRACT MODE : On
 (l) STAGE SELECT<VS GAME> : Off
 (m) EVENT MODE : Off
 (n) HIT COLOR : Mild
 (o) CHALLENGER AT TRAINING : On
 (p) CHALLENGER AT CONQUEST : On

Modify : P1-Left/Right
 Exit : P1-Start

2. Use the Joystick UP/DOWN to step to the required adjustment.
3. Use the Joystick LEFT/RIGHT to adjust the value.
4. When all adjustments have been made, press P1 Start Button to return to the Main Test Menu screen.

(a) Difficulty Level <Arcade> (degree of game difficulty)

Easy	Normal	Hard	Very Hard	Ultra Hard	Extremely Hard
------	--------	------	-----------	------------	----------------

(b) Fight Count <Arcade> (number of rounds required to win in 1-player mode)

1	2	3	4	5
---	---	---	---	---

(c) Fight Count <VS game > (number of rounds required to win the game in 1 competition mode)

1	2	3	4	5
---	---	---	---	---

(d) Life Bar<Arcade> (maximum level of energy gauge in 1-player mode)

80	90	100	110	120
----	----	-----	-----	-----

(e) Life bar <VS game > (maximum level of energy gauge in competition mode)

80	90	100	110	120
----	----	-----	-----	-----

(f) Round Time<Arcade> (time limit [seconds] per round)

30sec	35sec	40sec	45sec	50sec	55sec	60sec
-------	-------	-------	-------	-------	-------	-------

(g) Round Time<Training> (time limit [minutes] in Training mode)

3min	4min	5min	6min	7min	8min	9min	10min
------	------	------	------	------	------	------	-------

(h) Neutral guard (guard activated with lever in neutral)

ON	OFF
----	-----

(i) Character change at continue (change of character for continued game)

ON	OFF
----	-----

(j) Character change at VS game (change of character at the beginning of competition game bought-in by opponent)

ON	OFF
----	-----

(k) Sound in Attract mode

ON	OFF
----	-----

(l) Stage Select<VS game> (selection of stage at the beginning of competition mode)

ON	OFF
----	-----

(m) Event mode (Forced termination of game play after winner in competition game is determined)

ON	OFF
----	-----

(n) Hit colour (colour of graphic effects of attacks hit)

Normal	Mild
--------	------

(o) Challenger at Training (enables/disables setting for buy-in in Training mode)

ON	OFF
----	-----

(p) Challenger at Conquest (enables/disables setting for buy-in in Conquest mode)

ON	OFF
----	-----

* “Challenger at Conquest” (p) is not displayed until the Conquest mode becomes available a certain number of days after the date of installation.

6-2-7 Coin Options

- Select Coin Options from the Main Test Menu. The following screen is displayed.

COIN OPTIONS	
Defaults in Green	
(a)	> Start cost : 1 COIN to START
(b)	Continue cost : 1 COIN to CONTINUE
(c)	Coin chute 1 mechanical value : 1coin count as 1 COIN
(d)	Coin chute 2 mechanical value : 1coin count as 1 COIN
(e)	Credit mode : common
(f)	Coin counter : 1 counter
(g)	Free play : NO
Modify : P1-Left/Right	
Exit : P1-Start	

- Use the Joystick UP/DOWN to step to the required adjustment.
- Use the Joystick LEFT/RIGHT to adjust the value.
- When all adjustments have been made, press P1 Start Button to return to the Main Test Menu screen

Note: When using a CashFlow acceptor ensure that Cost and Coin Chute values are set to 1

(a) Start cost (number of credits to start a game)

1	2	3	4	5	6	7	8	9
---	---	---	---	---	---	---	---	---

(b) Continue cost (number of credits to continue a game - must be equal to or smaller than start cost)

1	2	3	4	5	6	7	8	9
---	---	---	---	---	---	---	---	---

(c) Coin chute 1 mechanical value (number of credits for each coin)

1	2	3	4	5	6	7	8	9
---	---	---	---	---	---	---	---	---

(d) Coin chute 2 mechanical value (number of credits for each coin)

1	2	3	4	5	6	7	8	9
---	---	---	---	---	---	---	---	---

(e) Credit Mode (credit storage and use)

<p>COMMON Credits are stored as a single account regardless of which coin switch or start switch is operated.</p>	<p>EACH ONE Different credit accounts are established. Credits from coin 1 are used by player 1 and credits from coin 2 are used by player 2</p>
--	---

(f) Coin counter (assignment of coin meters)

<p>1 COUNTER Both coin switches share one coin counter</p>	<p>2 COUNTERS Each coin switch has its own coin counter</p>
---	--

(g) Free play

YES (no coins required)	NO (coins required)
-------------------------	---------------------

6-2-8 Sound Test

1. Select Sound Test from the Main Test Menu. The following screen is displayed.

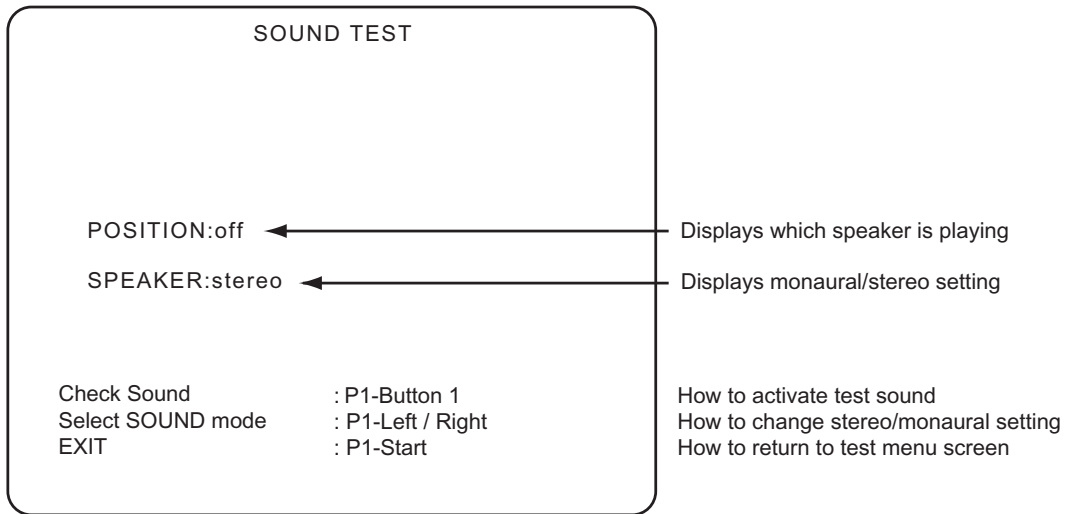

2. Press 1P Button 1 to conduct a stereo check. Sound will be produced from the left speaker only, then the right speaker only, then both speakers together. The display will show which speaker is active.
3. Use the Joystick LEFT/RIGHT to change between STEREO/MONO sound.
4. When testing has been completed, press P1 Start Button to return to the Main Test Menu screen

6-2-9 JVS Status

This test is inactive and not used on JAMMA system cabinets, it is only operational on JVS system cabinets.

6-2-10 A. D. S - (Bookkeeping)

This screen is used to display bookkeeping data such as: Total Coins, Game Ratios and Playing Times etc.

1. Select Bookkeeping from the Main Test Menu and press P1 Button 1 to display the information.
2. Press P1 Start Button to return to the Main Test Menu screen.

6-2-11 Data Clear

1. Select Data Clear from the Main Test Menu and press P1 Button 1. The following screen is displayed.

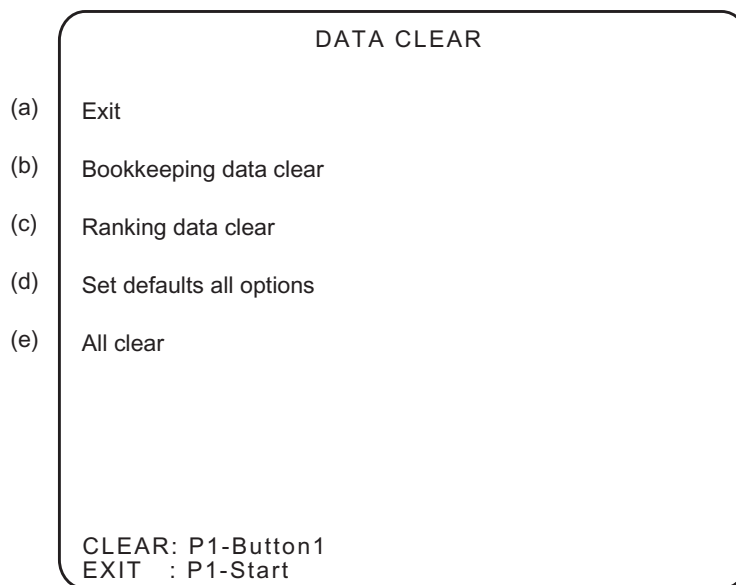

2. Use the Joystick UP/DOWN to step to the required adjustment.
 3. Press P1 button 1 to clear the selected data.
 4. When all adjustments have been made, press P1 Start Button to return to the Main Test Menu screen
- (a) Returns to the Main Test Menu.
 - (b) Resets all Bookkeeping data to zero
 - (c) Resets all ranking data such as record of consecutive wins to factory default
 - (d) Resets all Game and Coin Options to factory default.
 - (e) Executes (b), (c) and (d) all at once plus the data relating to the *Conquest mode.

****The Conquest mode becomes available after a certain number of days from date of installation.***

Copies of Namco Game Manuals can be downloaded from our **website:**

www.namco.co.uk

They are located under Components Distribution

For all Parts or Technical Support contact:

Brent Electronic,
Namco House,
Units 5-8, Acton Park Estate,
The Vale,
London. W3 7QE

www.brentelectronic.co.uk

For Technical Support, Warranty and

Advance Replacement Parts:-  +44 (0) 20 8324 6120

For Consumable Parts:-  +44 (0) 20 8324 6102

Fax for both:-  +44 (0) 20 8324 6126